

**PIGGY BACK CONTRACT FOR GOODS AND/OR SERVICES
FOR THE CITY OF KANSAS CITY, MISSOURI**

CONTRACT NO.: EVP2855

TITLE/DESCRIPTION: Aviation Furniture Replacement Project

THIS Contract is between KANSAS CITY, MISSOURI, a constitutionally chartered municipal corporation (“CITY” OR “PURCHASER”), and Arconas Furniture (“CONTRACTOR”).

Sec. 1. The Contract. The Contract between the CITY and CONTRACTOR consists of the following Contract Documents:

- (a) this Piggy Back Contract; and
- (b) CONTRACTOR’s Contract with GSA, (“the Primary Contract”) that is attached hereto and incorporated into this Contract; and

Furniture & Furnishing – Office Furniture
MAS – Multiple Award Schedule
Commodity: Furniture
Standard Industry Group: 337214 (NAICS)
Contract Number: GS-27F-018GA

- (c) any CITY issued Purchase Order to CONTRACTOR; and
- (d) any and all Attachments and Exhibits attached to the Primary Contract. All documents listed in this Section 1 shall be collectively referred to as the “Contract Documents” and are incorporated into this Contract. CITY and CONTRACTOR agree that the terms “Agreement” and “Contract” and “Contract Documents” are used interchangeably in this Contract and the terms “Agreement” and “Contract” and “Contract Documents” each include all “Contract Documents.”

Attachment A: Quote(s) from Arconas referencing GSA
Attachment B: MWBE Goals
Attachment C: Prevailing Wage
Attachment D: Bonds and Surety

Sec. 2. Definition. The term “Services” shall mean, depending on the context used in this Contract,:

- (a) Services; or
- (b) Goods, supplies, materials, equipment, products and software; or
- (c) Services **and** goods, supplies, materials, equipment, products and software, provided by CONTRACTOR to the CITY.

Sec. 3. Term of Contract.

- (a) Initial Term. The initial term of this Contract shall begin on December 9, 2021 and shall end on December 8, 2022.
- (b) Renewal Terms. At any time prior to the expiration of the initial term or any subsequent term, the CITY, in its sole discretion, may renew this Contract as long as the term of the Primary Contract and all renewal terms of the Primary Contract have not expired.
- (c) Transition Term. Notwithstanding the expiration of the initial term or any renewal term or all options to renew, CONTRACTOR and CITY shall continue performance under this Contract until the CITY has a new contract in place with either CONTRACTOR or another provider or until the CITY terminates the Contract.

Sec. 4. Purchase Orders.

- (a) All Services, to be provided by CONTRACTOR under this Contract shall be ordered by the CITY by means of a Purchase Order issued by the CITY. Notwithstanding Section 3 of this Contract, the CITY does not have any financial obligation under this Contract until the CITY issues a Purchase Order which shall be signed by the CITY's Director of Finance certifying there is a balance, otherwise unencumbered, to the credit of the appropriation to which the expenditure is to be charged, and a cash balance, otherwise unencumbered, in the treasury, to the credit of the fund from which payment will be made, each sufficient to meet the obligation incurred in the Purchase Order.
- (b) Subject to the terms and conditions of this Contract and in consideration for the Total Purchase Price ("Purchase Price") contained in each CITY issued Purchase Order, CONTRACTOR hereby agrees to provide all Services ordered pursuant to a CITY issued Purchase Order in accordance with this Contract.
- (c) CONTRACTOR shall not provide Services in excess of the Purchase Price in the Purchase Order and CONTRACTOR shall not be entitled to any payment in excess of the Purchase Price in the Purchase Order from CITY.

Sec. 5. Invoices. CITY shall pay CONTRACTOR after CITY determines that the Services supplied by CONTRACTOR are in conformance with the Contract and the CITY has accepted the Services. To obtain payment for Services supplied by CONTRACTOR pursuant to a CITY issued Purchase Order, CONTRACTOR shall submit to CITY an Invoice in sufficient detail for the CITY to determine that the amount CONTRACTOR is requesting is in fact due and payable. It shall be a condition precedent to payment of any invoice from CONTRACTOR that CONTRACTOR is in compliance with, and not in breach or default of, any terms, covenants and conditions of this Contract. If damages are sustained by CITY as a result of breach or default by CONTRACTOR, CITY may withhold payment(s) to CONTRACTOR for the purpose of setoff until such time as the exact amount of damages due CITY from CONTRACTOR may be determined.

Sec. 6. Representations and Warranties of CONTRACTOR. CONTRACTOR hereby represents and warrants to the CITY the following:

- (a) CONTRACTOR is in good standing under the laws of the state of Missouri and each state in which it does business, except any such state where the failure to be in good standing would not have a material adverse effect on CONTRACTOR's ability to perform this Contract in accordance with its terms.
- (b) The execution, delivery and performance by CONTRACTOR of this Contract have been duly authorized by all necessary corporate action and do not and will not (i) require any consent or approval of CONTRACTOR's board of directors; (ii) require any authorization, consent or approval by, or registration, declaration or filing with, or notice to, any governmental department, commission, board, bureau, agency or instrumentality, or any third party, except such authorization, consent, approval, registration, declaration, filing or notice as has been obtained prior to the date hereof; (iii) violate any provision of any law, rule or regulation or of any order, writ, injunction or decree presently in effect having applicability to CONTRACTOR or its articles or by-laws; and (iv) result in a breach of or constitute a default under any material agreement, lease or instrument to which CONTRACTOR is a party or by which it or its properties may be bound or affected.
- (c) CONTRACTOR shall not enter into any contract for the Services to be supplied by CONTRACTOR to CITY that purports to grant a security interest or right of repossession to any person or entity respecting the Services to be supplied by CONTRACTOR to CITY.
- (d) There is no litigation, proceeding or other investigation pending or, to the knowledge of CONTRACTOR, threatened against CONTRACTOR which would prevent consummation of the transaction contemplated by this Contract or would have a materially adverse effect on CONTRACTOR.

Sec. 7. Survival of the Representations, Warranties and Covenants. All representations, warranties and covenants expressed herein shall survive the execution of this Contract for the benefit of the parties hereto.

Sec. 8. Risk of Loss. Only upon delivery of the Services in accordance with the terms of this Contract to the CITY, the CITY shall bear the risk of damage, loss, theft, or condemnation of the Services regardless of cause, and any and all repairs and replacements of the Services or any part thereof shall be at the expense of the CITY subject, however, to the Warranty and other terms of this Contract.

Sec. 9. Governing Law. This Contract shall be construed and governed in accordance with the laws of the State of Missouri without giving effect to Missouri's choice of law provisions. The CITY and CONTRACTOR: (1) submit to the jurisdiction of the state and federal courts located in Jackson County, Missouri; (2) waive any and all objections to jurisdiction and venue; and (3) will not raise forum *non conveniens* as an objection to the location of any litigation.

Sec. 10. Termination for Convenience. CITY may, at any time upon ten (10) days written notice to CONTRACTOR specifying the effective date of termination, terminate this Contract, in whole or in part. If this Contract is terminated by CITY, CITY shall be liable only for payment for Services provided by CONTRACTOR before the effective date of termination.

Sec. 11. Default and Remedies.

- (a) If CONTRACTOR shall be in default or breach of any provision of this Contract, CITY may terminate this Contract, suspend CITY's performance, withhold payment or invoke any other legal or equitable remedy after giving CONTRACTOR ten (10) days written notice and opportunity to cure such default or breach.
- (b) If CITY shall be in default or breach of any provision of this Contract, CONTRACTOR may terminate this Contract or suspend CONTRACTOR's performance after giving CITY ten (10) days written notice and opportunity to cure such default or breach.

Sec. 12. Waiver. Waiver by CITY of any term, covenant, or condition hereof shall not operate as a waiver of any subsequent breach of the same or of any other term, covenant or condition. No term, covenant, or condition of this Contract can be waived except by written consent of CITY, and forbearance or indulgence by CITY in any regard whatsoever shall not constitute a waiver of same to be performed by CONTRACTOR to which the same may apply and, until complete performance by CONTRACTOR of the term, covenant or condition, CITY shall be entitled to invoke any remedy available to it under this Contract or by law despite any such forbearance or indulgence.

Sec. 13. Acceptance. No payment made under this Contract shall be proof of satisfactory performance of the Contract, either wholly or in part, and no payment shall be construed as acceptance of deficient or unsatisfactory Product.

Sec. 14. Records.

- (a) For purposes of this Section:
 - 1. "CITY" shall mean the CITY Auditor, the CITY's Internal Auditor, the CITY's Director of Human Relations, the CITY Manager, the CITY department administering this Contract and their delegates and agents.
 - 2. "Record" shall mean any document, book, paper, photograph, map, sound recordings or other material, regardless of physical form or characteristics, made or received in connection with this Contract and all Contract amendments and renewals.
- (b) CONTRACTOR shall maintain and retain all Records for a term of five (5) years that shall begin after the expiration or termination of this Contract and all Contract amendments. CITY shall have a right to examine or audit all Records, and CONTRACTOR shall provide access to CITY of all Records upon ten (10) days written notice from the CITY.
- (c) The books, documents and records of CONTRACTOR in connection with this Contract shall be made available to the CITY Auditor, the CITY's Internal Auditor, the CITY's Director of Human Relations and the CITY department administering this Contract within ten (10) days after the written request is made.

Sec. 15. Affirmative Action. If this Contract exceeds \$300,000.00 and Contractor employs fifty (50) or more people, Contractor shall comply with City's Affirmative Action requirements in

accordance with the provisions of Chapter 38 of City's Code, the rules and regulations relating to those sections, and any additions or amendments thereto; in executing any Contract subject to said provisions, Contractor warrants that it has an affirmative action program in place and will maintain the affirmative action program in place for the duration of the Contract. Contractor shall not discriminate against any employee or applicant for employment because of race, color, sex, religion, national origin or ancestry, disability, sexual orientation, gender identity or age in a manner prohibited by Chapter 38 of City's Code. Contractor shall:

- (a) Submit, in print or electronic format, a copy of Contractor's current certificate of compliance to the City's Human Relations Department (HRD) prior to receiving the first payment under the Contract, unless a copy has already been submitted to HRD at any point within the previous two (2) calendar years. If, and only if, Contractor does not possess a current certification of compliance, Contractor shall submit, in print or electronic format, a copy of its affirmative action program to HRD prior to receiving the first payment under the Contract, unless a copy has already been submitted to HRD at any point within the previous two (2) calendar years.
- (b) Require any Subcontractor awarded a subcontract exceeding \$300,000.00 to affirm that Subcontractor has an affirmative action program in place and will maintain the affirmative action program in place for the duration of the subcontract.
- (c) Obtain from any Subcontractor awarded a subcontract exceeding \$300,000.00 a copy of the Subcontractor's current certificate of compliance and tender a copy of the same, in print or electronic format, to HRD within thirty (30) days from the date the subcontract is executed. If, and only if, Subcontractor does not possess a current certificate of compliance, Contractor shall obtain a copy of the Subcontractor's affirmative action program and tender a copy of the same, in print or electronic format, to HRD within thirty (30) days from the date the subcontract is executed.

City has the right to take action as directed by City's Human Relations Department to enforce this provision. If Contractor fails, refuses or neglects to comply with the provisions of Chapter 38 of City's Code, then such failure shall be deemed a total breach of this Contract and this Contract may be terminated, canceled or suspended, in whole or in part, and Contractor may be declared ineligible for any further contracts funded by City for a period of one (1) year. This is a material term of this Contract.

Sec. 16. Tax Compliance. If the total Purchase Price exceeds \$160,000.00 from all Purchase Orders issued by the CITY for the period of May 1st through April 30th, CONTRACTOR shall provide proof of compliance with the CITY's tax ordinances administered by the CITY's Commissioner of Revenue as a precondition to the CITY making the first payment under this Contract. CONTRACTOR also shall submit to the CITY proof of compliance with the CITY's tax ordinances administered by the CITY's Commissioner of Revenue as a condition precedent to the CITY making final payment under the Contract.

Sec. 17. Buy American Preference. It is the policy of the CITY that any manufactured goods or commodities used or supplied in the performance of any CITY Contract or any subcontract thereto shall be manufactured or produced in the United States whenever possible.

Sec. 18. Notices. All notices to be given hereunder shall be in writing and may be given, served or made by depositing the same in the United States mail addressed to the party to be notified, postpaid and registered or certified with return receipt requested or by delivering the same in person to such person. Notice deposited in the mail in accordance with the provisions hereof

shall be effective unless otherwise stated in such notice or in this Contract from and after the second day next following the date postmarked on the envelope containing such notice. Notice given in any other manner shall be effective only if and when received by the party to be notified. All notices shall be sent to the following addresses:

If to the CITY: City of Kansas City, Missouri
Procurement Services Division
414 East 12th Street, 1st Floor, Room 102 W
Kansas City, Missouri 64106
Attention: Cedric Rowan, C.P.M., Manager
Telephone: (816) 513-0814
Facsimile: (816) 513-1066

With copies to: Matthew J. Gigliotti, Esq.
City Attorney
Law Department of Kansas City, Missouri
414 East 12th Street, 23rd Floor
Kansas City, Missouri 64106
Telephone: (816) 513-3153

If to the CONTRACTOR: ARCONAS Corporation
5700 Keaton Crescent
Mississauga, Ontario
Canada L5R 3H5

Sec. 19. General Indemnification.

- (a) For purposes of this Section only, the following terms shall have the meanings listed:
 - 1. **Claims** means all claims, damages, liability, losses, costs and expenses, court costs and reasonable attorneys' fees, including attorneys' fees incurred by the CITY in the enforcement of this indemnity obligation.
 - 2. **CONTRACTOR's Agents** means CONTRACTOR's officers, employees, subcontractors, successors, assigns, invitees, and other agents.
 - 3. **CITY** means CITY, its Agencies, its agents, officials, officers and employees.
- (b) CONTRACTOR's obligations under this Section with respect to indemnification for acts or omissions, including negligence, of CITY, shall be limited to the coverage and limits of insurance that CONTRACTOR is required to procure and maintain under this Contract. CONTRACTOR affirms that it has had the opportunity to recover all costs of the insurance requirements imposed by this Contract in its contract price.
- (c) CONTRACTOR shall defend, indemnify and hold harmless CITY from and against all claims arising out of or resulting from all acts or omissions in connection with this Contract caused in whole or in part by CONTRACTOR or CONTRACTOR's

Agents, regardless of whether or not caused in part by any act or omission, including negligence, of CITY. CONTRACTOR is not obligated under this Section to indemnify CITY for the sole negligence of CITY.

- (d) In no event shall the language in this Section constitute or be construed as a waiver or limitation of the CITY's rights or defenses with regard to sovereign immunity, governmental immunity, or other official immunities and protections as provided by the federal and state constitutions or by law.

Sec. 20. Insurance.

- (a) CONTRACTOR shall procure and maintain in effect throughout the duration of this Contract insurance coverage not less than the types and amounts specified in this section. In the event that additional insurance, not specified herein, is required during the term of this Contract, CONTRACTOR shall supply such insurance at CITY's cost. Policies containing a Self-Insured Retention are unacceptable to CITY unless CITY approves in writing the CONTRACTOR's Self-Insured Retention.

- 1. Commercial General Liability Insurance: with limits of \$1,000,000 per occurrence and \$2,000,000 aggregate, written on an "occurrence" basis. The policy shall be written or endorsed to include the following provisions:

- a. Severability of Interests Coverage applying to Additional Insureds.
- b. Per Project Aggregate Liability Limit or, where not available, the aggregate limit shall be \$2,000,000.
- c. No Contractual Liability Limitation Endorsement.
- d. Additional Insured Endorsement, ISO form CG20 10, or its equivalent.

- 2. If applicable, Workers' Compensation Insurance, as required by *statute*, including Employers Liability with limits of:

Workers' Compensation Statutory Employers Liability \$100,000
accident with limits of:

\$500,000 disease-policy limit
\$100,000 disease-each employee

- 3. Commercial Automobile Liability Insurance: with a limit of \$1,000,000 per occurrence, covering owned, hired, and non-owned automobiles. Coverage provided shall be on an "any auto" basis and written on an "occurrence" basis. This insurance will be written on a Commercial Business Auto form, or acceptable equivalent, and will protect against claims arising out of the operation of motor vehicles, as to acts done in connection with the Contract, by CONTRACTOR.

- (b) The Commercial General Liability Insurance specified above shall provide that CITY and its agencies, officials, officers, and employees, while acting within the scope of their authority, will be named as additional insureds for the services performed under this Contract. CONTRACTOR shall provide to CITY at execution of this Contract a certificate of insurance showing all required endorsements and

additional insureds. The certificates of insurance will contain a provision stating that should any of the policies described in the certificate be cancelled before the expiration date thereof, notice will be delivered in accordance with the policy provisions.

- (c) All insurance coverage must be written by companies that have an A.M. Best's rating of "A-V" or better, and are licensed or approved by the State of Missouri to do business in Missouri.
- (d) CONTRACTOR's failure to maintain the required insurance coverage will not relieve CONTRACTOR of its contractual obligation to indemnify the CITY pursuant to Section 19. If the coverage afforded is cancelled or changed or its renewal is refused, CONTRACTOR shall give at least thirty (30) days prior written notice to CITY. In the event of CONTRACTOR's failure to maintain the required insurance in effect, CITY may order CONTRACTOR to immediately stop work, and upon ten (10) days notice and an opportunity to cure, may pursue its remedies for breach of this Contract as provided for herein and by law.
- (e) In no event shall the language in this Section constitute or be construed as a waiver or limitation of the CITY's rights or defenses with regard to sovereign immunity, governmental immunity, or other official immunities and protections as provided by the federal and state constitutions or by law.

Sec. 21. Interpretation of the Contract. The terms and conditions of this Piggy Back Contract take precedence over the terms and conditions of the Primary Contract if there is any conflict between the terms and conditions of the Piggy Back Contract and the Primary Contract. The CITY's Manager of Procurement Services shall resolve all disagreements or any ambiguity in this Agreement. The decision of CITY's Manager of Procurement Services shall be final and conclusive if the Manager of Procurement Services acted in good faith.

Sec. 22. Contract Execution. This Contract may be executed in one or more counterparts, each of which will be deemed an original copy of this Contract and all of which, when taken together, will be deemed to constitute one and the same Contract. This Contract shall be effective upon the execution of counterparts by both parties, notwithstanding that both parties may not sign the same counterpart. The parties' signatures transmitted by facsimile or by other electronic means shall be proof of the execution of this Contract and shall be acceptable in a court of law.

Sec. 23. Guaranteed Lowest Pricing. CONTRACTOR certifies that the Primary Contract contains CONTRACTOR's lowest and best pricing for all Product supplied by CONTRACTOR to any government, governmental entity, political subdivision, city, state, school district or any other public entity in the United States as of the date of this Contract.

Sec. 24. Assignability and Subcontracting.

- (a) Assignability. Contractor shall not assign or transfer any part or all of Contractor's obligation or interest in this Contract without prior written approval of City. If Contractor shall assign or transfer any of its obligations or interests under this Contract without the City's prior written approval, it shall constitute a material breach of this Contract. This provision shall not prohibit contractor from subcontracting as otherwise provided for herein.

- (b) Subcontracting. Contractor shall not subcontract any part or all of Contractor's obligations or interests in this Contract unless the subcontractor has been identified in a format required by City. If Contractor shall subcontract any part of Contractor's obligations or interests under this Contract without having identified the subcontractor, it shall constitute a material breach of this Contract. The utilization of subcontractors shall not relieve Contractor of any of its responsibilities under the Contract, and Contractor shall remain responsible to City for the negligent acts, errors, omissions or neglect of any subcontractor and of such subcontractor's officers, agents and employees. City shall have the right to reject, at any point during the term of this Contract, any subcontractor identified by Contractor, and to require that any subcontractor cease working under this Contract. City's right shall be exercisable in its sole and subjective discretion. City shall not be obligated to pay or be liable for payment of any monies which may be due to any subcontractor. Contractor shall include in any subcontract a requirement that the subcontractor comply with all requirements of this Contract in performing Contractor's services hereunder.

Sec. 25. Emergencies.

- (a) "Emergency" means any large scale event such as an act of terrorism, major snow or ice storm, fire, wind, tornado, flood, earthquake, major storm or other natural or man-made calamity which results in, or has the potential to result in a significant loss of life or property.
- (b) During and after an emergency, CONTRACTOR shall provide special services to the CITY including CONTRACTOR shall open CONTRACTOR's facilities even on nights and weekends as necessary to meet the needs of the CITY during a disaster.
- (c) CONTRACTOR shall not charge CITY any fee for opening facilities during an emergency or for extending CONTRACTOR's hours of operation during an emergency. CITY shall pay CONTRACTOR the agreed upon contract prices for all purchases made by CITY during the emergency and CONTRACTOR shall not charge CITY any additional mark-up, fee or cost for any purchases made by CITY during an emergency.
- (d) CONTRACTOR shall quickly mobilize CONTRACTOR's internal and external resources to assist CITY when an emergency unfolds.
- (e) Extended hours and personnel. During an emergency, CONTRACTOR's facilities shall stay open 24 hours if requested by the CITY. CONTRACTOR shall utilize additional CONTRACTOR personnel to take CITY orders if necessary. CONTRACTOR's Call Center shall accept phone orders 24 hours a day.
- (f) CONTRACTOR shall have contingency plans with CONTRACTOR's suppliers to provide additional supplies and equipment quickly to CITY as needed.
- (g) CONTRACTOR shall cooperate with CITY to properly document any and all expenses incurred by CITY with CONTRACTOR and CONTRACTOR shall assist CITY in meeting any and all documentation requirements of the Federal Emergency Management Agency (FEMA).

Sec. 26. Compliance with Laws. CONTRACTOR shall comply with all federal, state and local laws, ordinances and regulations applicable to all the Product to be provided by CONTRACTOR to the CITY in this Contract.

Sec. 27. Employee Eligibility Verification. If this Contract exceeds five thousand dollars (\$5,000.00), CONTRACTOR shall execute and submit an affidavit, in a form prescribed by CITY, affirming that CONTRACTOR does not knowingly employ any person in connection with the contracted services who does not have the legal right or authorization under federal law to work in the United States as defined in 8 U. S. C. § 1324a(h)(3). CONTRACTOR shall attach to the affidavit documentation sufficient to establish CONTRACTOR'S enrollment and participation in an electronic verification of work program operated by the United States Department of Homeland Security (E-Verify) or an equivalent federal work authorization program operated by the United States Department of Homeland Security to verify information of newly hired employees, under the Immigration Reform and Control Act of 1986.

CONTRACTOR may obtain additional information about E-Verify and enroll at <https://e-verify.uscis.gov/enroll/StartPage.aspx?JS=YES>. If CONTRACTOR is enrolled in E-Verify, the first and last pages of the E-Verify Memorandum of Understanding that CONTRACTOR will obtain upon successfully enrolling in the program shall constitute sufficient documentation for purposes of complying with this Section. CONTRACTOR shall submit the affidavit and attachments to the CITY prior to execution of the Contract, or at any point during the term of the Contract if requested by CITY.

Sec. 28. Quality Services Assurance Act. If this Contract exceeds \$160,000.00, CONTRACTOR certifies CONTRACTOR will pay all employees who will work on this Contract in the city limits of Kansas City, Missouri at least \$12.50 per hour in compliance with the CITY's Quality Services Assurance Act, Section 3-66, Code of Ordinances or CITY has granted CONTRACTOR an exemption.

Sec. 29. Anti-Discrimination Against Israel. If this Contract exceeds \$100,000.00 and CONTRACTOR employs at least ten employees, pursuant to Section 34.600, RSMo., by executing this Contract, CONTRACTOR certifies it is not currently engaged in and shall not, for the duration of this contract, engage in a boycott of goods or services from the State of Israel; companies doing business in or with Israel or authorized by, licensed by, or organized under the laws of the State of Israel; or persons or entities doing business in the State of Israel.

CONTRACTOR

I hereby certify that I have the authority to execute
this document on behalf of CONTRACTOR.

Contractor: _____

By: _____

Title: _____

Date: _____

APPROVED AS TO FORM

Assistant City Attorney (Date)

KANSAS CITY, MISSOURI

By: _____

Title: _____

Date: _____

Attachment A: GSA Quotes

CONFIRMATION

Date 15-Sep-2021
Number 35171-0016
Layout Revision No
Customer No C000308
Page 1 of 4
Price List US Price List

Bill To: KANSAS CITY INTERNATIONAL
 AIRPORT
 Kansas City Aviation Department
 601 Brasilia Avenue
 P.O BOX # 20047
 Kansas City MO 64153
 United States
 Ian Redhead

Ship To: KCI Airport
 1 International Square
 Attn: John Rutledge (816-800-2920)
 Kansas City MO 64153
 United States

Order No	Cust PO	Territory	Ship Date	Ship Via	Terms
35171-0016	NTP 06-29-21	KT	10-Feb-2023	Best way	1/3 Order, 1/3 Ship, 1/3 N30 (OAC)

Qty	Item	Description	List Price	Discount	Net Price	Extended Price
-----	------	-------------	------------	----------	-----------	----------------

Project: MCI - Kansas City International Airport - New Terminal Security

GSA Contract# GS-27F-018GA

FLYAWAY BENCH SERIES

Seats Finish: Stainless Steel Tops

Finish: Satin Aluminum

Glide Type: Non Slip (for tiled flooring)

****Units to ship Assembled****

20	FLY3B	Flyaway 3 Seat Bench Unit			1,907.00	38,140.00
		Base Price	1,807.00			
		Non Slip Glide Glide Price :	100.00			
		Seats Per Unit : 3				
		Total	1,907.00			

60	Assembly	Assembly at Arconas			50.00	3,000.00
----	----------	---------------------	--	--	-------	----------

1	Discount	Volume Discount 1%			(381.40)	-381.40
---	----------	--------------------	--	--	----------	---------

1	HT-FLY	Tapping Kit for Flyaway			0.00	0.00
---	--------	-------------------------	--	--	------	------

Ship to: Kansas City, MO 64153

1	Freight	Freight			2,780.00	2,780.00
---	---------	---------	--	--	----------	----------

INSTALLATION NOT INCLUDED, PRODUCT TO SHIP ASSEMBLED

Freight charge is based on dock-to-dock delivery, during regular business hours.

Estimated delivery to client: 10-12 weeks from receipt of purchase order, plus shipping



CONFIRMATION

Date 15-Sep-2021
Number 35171-0016
Layout Revision No
Customer No C000308
Page 2 of 4
Price List US Price List

Bill To: KANSAS CITY INTERNATIONAL
 AIRPORT
 Kansas City Aviation Department
 601 Brasilia Avenue
 P.O BOX # 20047
 Kansas City MO 64153
 United States
 Ian Redhead

Ship To: KCI Airport
 1 International Square
 Attn: John Rutledge (816-800-2920)
 Kansas City MO 64153
 United States

Order No	Cust PO	Territory	Ship Date	Ship Via	Terms
35171-0016	NTP 06-29-21	KT	10-Feb-2023	Best way	1/3 Order, 1/3 Ship, 1/3 N30 (OAC)

Qty	Item	Description	List Price	Discount	Net Price	Extended Price
		*Freight charges subject to revision at time of shipping			Product	40,758.60
		*Discounts do not apply to shipping, installation & assembly			Installation	0.00
		*Unless specified, any form of Sales / Value Added Tax is excluded			Freight	2,780.00
					Subtotal	43,538.60
		Total Seats <input type="text" value="60"/>			GST	0.00
		Total Tables <input type="text"/>			HST Not Applicable	0.00
		CRA/EIN: 738279892			Total:	43,538.60
		Printed on: 22/09/2021 11:31:08 AM				USD

Date 15-Sep-2021
Number 35171-0016
Layout Revision No
Customer No C000308
Page 3 of 4
Price List US Price List

TERMS OF SALE

Standard Terms of Sale. Unless otherwise agreed to in writing between Arconas Corporation ("Arconas") and the recipient of Arconas' quotation (the "Customer") for the sale of products (the "Products") the following terms:

(a) are part of Arconas' quotation for the sale of Products and acceptance by Arconas of any resulting order from the Customer (the "Order"); (b) shall become the exclusive and binding agreement between Arconas and the Customer with respect to the Order (the "Agreement"); and (c) shall apply to any purchase order issued by the Customer in connection with an Order, regardless of whether these terms are expressly referenced in that purchase order. No term set forth in any of the Customer's form of solicitation, purchase order, or contract shall become part of the Agreement or otherwise become binding on Arconas unless expressly agreed to in writing by Arconas.

Change Orders. Substitutions, deletions, additions or other changes to an Order may not be made by a Customer without the written approval of Arconas. Change Order reductions greater than \$10,000 will incur costs as outlined in our Cancellation Clause below.

Warranty. Arconas shall provide a warranty on the Products in accordance with the terms of the warranty made available to the Customer in connection with the Order.

Freight. Freight terms shall be as described in the Order.

Prices, Payment and Taxes.

The purchase price for the Products as described in Arconas' quotation is F.O.B. Arconas' factory (the "Purchase Price"). Payment terms shall be as described in Arconas' quotation.

If any undisputed amount payable by the Customer under this Agreement is not paid when due, Arconas may assess and, if so assessed, the Customer shall pay a late charge at the rate of twelve percent (12%) of the outstanding amount (or at highest rate permitted by law, whichever is lower), per annum, pro rated on a daily basis. If an invoiced item is disputed, the Customer must give Arconas written notice of such dispute with full particulars thereof within thirty (30) days after the Customer's receipt of the applicable invoice. If the Customer disputes an invoiced item and such invoiced item is upheld in Arconas' favour, then such late payment charge provided for herein shall apply to the time period starting ten (10) days from the date on which the dispute is resolved. If the invoice contains an error, the Customer shall notify Arconas of such error and late charges shall apply thirty (30) days after the Customer's receipt of a corrected invoice.

Unless expressly provided for in Arconas' quotation and the Order, the Purchase Price does not include any applicable taxes, duties or other assessments that are applicable to the Order. The Customer shall pay any applicable taxes, duties or other assessments of a governmental authority and related interest and penalties relating to the Order (excluding taxes on Arconas' income). The Customer shall forthwith provide Arconas with copies of any documents which are reasonably requested by Arconas to evidence the remittance of any taxes, duties or other assessments relating to the self-assessment and remittance of taxes, duties or other assessments paid by the Customer relating to an Order. The Customer shall indemnify and save Arconas and Arconas' directors harmless from any taxes, duties, assessments, penalties, interest or other amounts which may be payable by or assessed against Arconas or its directors as a result of or in connection with the Customer's failure to pay in full when due all taxes, duties or other assessments relating to an Order.

Cancellation. A Customer may not cancel any order without Arconas' approval and then only upon payment of the applicable cancellation charges set forth herein. The effective date of any approved cancellation shall be the date that Arconas receives notice from the Customer of its request to cancel an order (the "Cancellation Date"). Cancellation charges shall be assessed as follows: (i) for orders scheduled to ship within ten (10) days of the Cancellation Date, cancellation charges shall be one hundred percent (100%) of the Purchase Price; (ii) for shipments scheduled beyond ten (10) days from the Cancellation Date, cancellation charges shall be fifty percent (50%) of the Purchase Price. Arconas is under no obligation to accept any order cancellation and may refuse any Customer request for cancellation in Arconas' sole discretion. In the event of an approved cancellation, Arconas shall have the right to retain any funds paid in the form of a progress or deposit payment, as applicable, towards satisfaction of a cancellation charge payable hereunder.

Events of Default. The occurrence of any one of the following events before payment in full is received by Arconas shall be an "Event of Default": (a) the Customer fails to make a payment when due and payable; (b) the Customer fails or neglects to perform any of its obligations hereunder; (c) the Customer makes any false or misleading representation to Arconas in connection with this Agreement; (d) the Customer enters into any arrangement with its creditors or any of them or suspends payment generally or is otherwise unable to pay its debts as they become due; (e) a receiver for the Customer or any material portion of its property is appointed or steps are taken for the appointment of such receiver by any person or entity; (f) if a bankruptcy, liquidation, insolvency or other similar proceeding is filed by or against the Customer, and in the case of an involuntary proceeding, is not vacated or set aside within sixty (60) days of its commencement; or (g) a breach or default by the Customer occurs under any other agreement between the Customer and Arconas or with respect to any other obligation of the Customer to Arconas. Upon the occurrence of an Event of Default, in addition to any other remedies available to Arconas under this Agreement or at law, Arconas shall have the right to terminate this Agreement and retain any funds paid in the form of a progress or deposit payment, as applicable, towards satisfaction of any expenses, costs, damages or other liabilities incurred by Arconas related to the Event of Default.

Title to Products and Arconas Security Interest. So long as any amount of the Purchase Price and any other charges payable hereunder in connection with an Order remain outstanding, title to the Products shall remain with Arconas. Arconas hereby retains and the Customer hereby grants to Arconas a security interest in the Products purchased hereunder until the Customer has made payment in full for the Products. The Customer shall execute, deliver or endorse any and all instruments, documents, assignments, security agreements and other agreements and writings that Arconas may at any time reasonably request in order to secure, protect, perfect or enforce the security interest and Arconas' rights under this Agreement. Arconas shall have all of the rights of a secured party with respect to the Products purchased hereunder under applicable laws. Upon the Customer's default of any payment obligation, in addition to other rights and remedies it has under this Agreement and may have at law, Arconas may exercise all the rights and remedies of a secured party in respect of the Products on default under applicable law, including, without limitation, the right to enforce the security interest to retake possession of any or all of the Products. Upon payment of the Purchase Price and all other charges payable by the Customer in connection with an Order, title to the Products shall transfer to the Customer and the security interest granted hereunder to Arconas shall be discharged.

Compliance with Law. The Customer shall comply with all laws, ordinances, rules, regulations, codes and orders of any authority having jurisdiction over the Customer and which relate to the Customer's installation, maintenance and use of the Products. If the Customer's installation or use of any Products contravenes any such laws, ordinances, rules, regulations, codes or orders of such authorities, the Customer shall be responsible for the violations thereof and shall bear the costs, expense and damages attributable to its failure to comply with the provisions of such laws, ordinances, rules, regulations, codes or orders.

Indemnification. The Customer shall indemnify, defend and hold Arconas harmless from and against any and all claims, actions, losses, damages, demands, liabilities, costs and expenses, including reasonable attorney's fees and expenses, whether or not a suit or other proceeding is initiated, which may arise from, but not limited to, the following events: (i) representations or misrepresentations made by the Customer, (ii) any neglect by the Customer or end-users, (iii) the Customer's or end-users' use of the Products not in compliance with the Products' intended purposes, (iv) installation of the Products by the Customer is not in accordance with Arconas' installation guidelines, (v) Customer's or end-users' modifications or alterations of Products that have not been approved by Arconas, (vi) damage from Customer or end-user misuse of the Products, or (vii) any other act, or failure to act, not in accordance with the terms of this Agreement by the Customer, or any other breach by the Customer of any covenants of the Customer under this Agreement.

Governing Law; Consent to Jurisdiction. This Agreement shall be governed by and construed in accordance with the laws of the Province of Ontario, Canada. The application of the United Nations Convention for the International Sale of Goods is excluded and shall not apply to any purchase and sale made hereunder. Any legal suit or action arising out of or relating to this Agreement may be instituted in a court of competent jurisdiction in Ontario, Canada and the Customer waives any objection which it may now otherwise have or hereafter have to the waiving of the venue of any such suit, action or proceeding and hereby subjects itself to the jurisdiction of any such court.

Assignment. The Customer may not assign, transfer or otherwise encumber this Agreement or any part thereof without express written consent of Arconas. Arconas may assign and transfer this Agreement or any interest or right hereunder or any interest or right in the Products and/or grant a security interest in the Products, in whole or in part. Subject to the foregoing, this Agreement shall inure to the benefit of, and is binding upon, the successors and permitted assigns of the parties.

Force Majeure. A party's obligations hereunder will be excused during any time period when it is unable to perform such obligations hereunder due to circumstances beyond its reasonable control, including but not limited to fire, flood, embargoes, war, strikes, lockouts or other labour disturbances, shortages of labour or materials, acts of God, omissions or delays in acting by any governmental authority or other party. The party so affected, upon giving prompt written notice to the other party, shall be excused from performance of its obligations hereunder to the extent of the duration of such event provided that such party shall use its reasonable commercial efforts to avoid or remove such event.

Time. Time is of the essence hereof.

Entire Agreement. The Customer's acceptance of any Products purchased under this Agreement shall be deemed acceptance of all the terms and conditions stated herein. Arconas' failure to object to any provisions contained in any communication from the Customer shall not be deemed a waiver of the provisions contained herein. This Agreement represents the entire agreement between the parties relating to the subject matter hereof and shall supersede all prior written or oral understandings and/or other terms in any purchase order or other document, now or hereafter delivered, except that this Agreement shall not supersede other written agreements between the parties that expressly reference this Agreement.

Date 15-Sep-2021
Number 35171-0016
Layout Revision No
Customer No C000308
Page 4 of 4
Price List US Price List

Payment Options

Cheques

Please submit your cheques to:

Arconas Corporation
Attention: Accounts Receivable
5700 Keaton Crescent
Mississauga, Ontario
L5R 3H5 – Canada

IMPORTANT: All payments by cheque of \$10,000.00 or greater, must be sent by courier, using Arconas Fedex account number 2670-6660-4.

Wire Transfer Option

Canadian Customers (CAD):

Bank: Bank of Montreal 100 King Street West Toronto, Ontario M5T 1T4	Beneficiary Name/Address: Arconas Corporation 5700 Keaton Crescent Mississauga, Ontario L5R 3H5	Institution: 001 Transit: 00022 Account Number: 1821 537
--	--	--

U.S. Customers (USD):

Bank: BMO Harris 111 W. Monroe Chicago, IL 60603	Beneficiary Name/Address: Arconas Corporation 5700 Keaton Crescent Mississauga, Ontario L5R 3H5	Account Number: 4822578674 ABA Number: 071025661 Swift Number: HATRUS44 Routing Number: 071025661
--	--	--

International (excluding U.S.) Customers:

Bank: Bank of Montreal 100 King Street West Toronto, Ontario M5T 1T4	Beneficiary Name/Address: Arconas Corporation 5700 Keaton Crescent Mississauga, Ontario L5R 3H5	Institution: 001 Transit: 00022 Swift Code: BOFMCAM2 Account Number: 4640 570
--	--	---

Please send wire confirmation to movando@arconas.com

If you have any questions please contact Mynor Ovando: 905-272-0727 ex.307

MCI - Kansas City International Airport

Layouts dated May 13, 2021

FLYAWAY SERIES

Uph: Grade A Esprit Vinyl CAL117, Color: Graphite
Satin Aluminum Finish



NEW SEATING - Pricing until May 2021

Description	2-seat	3-seat	4-seat	5-seat	Total Seats	Total Arms	50% Drink Holders	B2B Retro Connectors	Companion Seats (CS)	FLYLEGF Front Leg	100% Power	8ft Jumpers	CMD Single	CMD 4 seat	CMD 5-seat	
Gate B40-B44	4	9	15	24	215	267	139	18	3		100	24	22	15	24	
Gate B41-45	6	15	10	30	247	308	156	24	3		116	30	36	10	30	
Gate B46	4	6	15	38	276	339	175	25	2		122	38	16	15	38	
Gate B47	8	10	26	24	270	338	178	32	3		128	24	28	26	24	
Gate B48-B52	0	12	12	30	234	288	150	24	5		108	30	24	12	30	
Gate B49-B51	0	39	16	6	211	272	144	28	5		122	6	78	16	6	
Gate B54-B56	0	4	23	24	224	275	149	23	6		102	24	8	23	24	
Gate B57	0	8	23	5	141	177	100	16	5		72	5	16	23	5	
Gate B58-B60	0	8	26	30	278	342	184	32	5		128	30	16	26	30	
Gate B59-B61	0	3	35	12	209	259	147	23	5		100	12	6	35	12	
Gate B62	0	2	36	28	290	356	196	31	4		132	28	4	36	28	
Gate B63	0	3	32	28	277	340	186	29	4		126	28	6	32	28	
Gate B64-B65	0	9	30	47	382	468	249	39	1		172	47	18	30	47	
Gate B66-B69	2	18	19	23	249	311	164	27	6		122	23	38	19	23	
					0	0	0				0	0	0	0	0	
Gate A20	0	24	12	18	210	264	138	22	5		108	18	48	12	18	
Gate A16	0	12	4	0	52	68	36	8	2		32	0	24	4	0	
Gate A12-A14	0	24	21	25	281	351	186	34	4		140	25	48	21	25	
Gate A10	0	5	9	14	121	149	79	11	5		56	14	10	9	14	
Gate A8	0	2	32	15	209	258	145	24	2		98	15	4	32	15	
Gate A5-6	0	2	36	34	320	392	214	36	4		144	34	4	36	34	
Gate A4-A1	0	4	14	32	228	278	146	25	4		100	32	8	14	32	
					0	0	0				0	0	0	0	0	
Existing		-53	-79	-105	-1000	-1237	-417			84					-28	
					0	0	0				0					
Total Units	24	166	367	382	3924	4863	2844	531	83	84	2328	487	462	446	459	
Unit Prices	\$ 1,421.00	\$ 1,951.00	\$ 2,481.00	\$ 3,037.00		\$ 34.00	\$ 63.00	\$ 230.00	\$ 30.00	\$ 31.00	\$ 480.00	\$ 11.00	\$ 31.00	\$ 62.00	\$ 93.00	
TOTALS	\$ 34,104.00	\$ 323,866.00	\$ 910,527.00	\$ 1,160,134.00	\$ -	\$ 165,342.00	\$ 179,172.00	\$ 122,130.00	\$ 2,490.00	\$ 2,604.00	\$ 1,117,440.00	\$ 5,357.00	\$ 14,322.00	\$ 27,652.00	\$ 42,687.00	\$ 4,107,827.00

***Project Total Seats Including Existing 4924

NOTES:

Standard Payment Terms: 1/3 with order, 1/3 upon shipping by truck, 1/3 Net 30 Days OAC

Pricing in effect if order received by May 31, 2021.

Escalator of 3% for order received by Dec 31, 2021.

Pricing does not include waste/recycling units

*Assembly & Installation is only a not to exceed estimate number. Once site conditions, hours of work, etc are determined, a new quote can be done.

New Covers for Existing Seats for CS Embroidery \$ 2,262.00

Standard 5% Volume Discount -\$ 205,504.45

One Time Additional 10% Volume Discount -\$ 411,008.90

One Time Additional 10% Discount for Progress Payments* -\$ 411,008.90

Freight \$ 41,700.00

*Assembly & Installation \$ 879,800.00

Sales & Use Tax Not included

Grand Total \$ 4,004,066.75

Attachment B: MWBE Goals

The goals on this contract are 0% MBE and 16% WBE with Superior Moving.

Approved CREO paperwork is attached.



CREO KC Contractor Utilization Plan Approval

Date: 10/28/2021
 To: Civil Rights & Equal Opportunity Department
 From: Keely Golden, Procurement Manager, Procurement Services, GSD
 Subject: Contract/Project No.: EVP2855
 Project Title: Aviation/Terminal Seating Replacement Project

Funding: <input checked="" type="checkbox"/> City (MBE/WBE/DBE) <input type="checkbox"/> Federal (DBE) ¹ <input type="checkbox"/> State (DBE) ¹ - Grant _____ <input type="checkbox"/> Other: TIF <input checked="" type="checkbox"/>	
Contract Category: <input type="checkbox"/> Construction <input checked="" type="checkbox"/> General Service <input type="checkbox"/> Facility Repair <input type="checkbox"/> Design Professional <input type="checkbox"/> Professional Services <input type="checkbox"/> Concession <input checked="" type="checkbox"/> Other: Furniture purchase	
Bid/Proposal Closing Date: n/a	No. of Bidders/Proposers: n/a
Recommended Bid/Proposal²: \$4,047,605	
Company: Arconas Furniture Company Contact: Krista Tapley, Sales Director Contact Email: ktapley@arconas.com	Address: 5700 Keaton Crescent, Mississauga, ON L5R 3H5 Phone: 800-387-9496 Fax: 905-897-7470
Additional Information: Arconas has Superior Moving as an authorized service/installation technician already certified with their company. The only portion of the total scope available to subcontract is the installation of the furniture. Arconas is requesting to meet the 10.5% MBE and 10.5% WBE goals with Superior Moving for a total of 28.5% MBE and 0% WBE. They do not have any other local MWBE companies certified as authorized service/installation technicians. Procurement and Aviation support this request, we hope that CREO will approve as well.	

cc: Project Manager:

FOR CIVIL RIGHTS & EQUAL OPPORTUNITY DEPARTMENT USE ONLY	
The attached Contractor Utilization Plan is:	
<input checked="" type="checkbox"/> Approved	The Request for Best Faith Efforts Waiver is:
<input type="checkbox"/> Disapproved	<input checked="" type="checkbox"/> Approved
	<input type="checkbox"/> Disapproved
	<input type="checkbox"/> Not Applicable
Contractor Utilization Plan Participation: <u>N/A</u> % MBE & <u>16</u> % WBE	or _____ % DBE
DocuSigned by: Civil Rights & Equal Opportunity Department	11/23/2021 Date

FOR GRANTING AGENCY USE ONLY³ <input type="checkbox"/> N/A
Approved by: _____ Date: _____

¹ DBE Programs apply to specific federal or state grant requirements.

² The dollar figure here should match the approved Bid/Proposal recommendation or amendment preparation checklist on file with the requesting department.

³ Federal and state grant agreements may require granting agency approval of contract goals.

The documented good faith efforts that created genuine opportunities for participation. Despite these efforts, the additional outreach revealed there are no minority business enterprises available to participate. Therefore the request for waiver is approved.

Inter-Departmental Communication

Date: October 28, 2021

To: Mayor Quinton Lucas; Chair: Transportation, Infrastructure & Operations Committee

From: Andrea Dorch; Director; Civil Rights & Equal Opportunity Department

Subject: Docket Memo #:

CONTRACTOR: Arconas Furniture Co.
Address: 5700 Kenton Crescent
Mississauga, ON L5R 3H5 CANADA
Contract # EVP2855 – Aviation Terminal Seating Replacement Project
Contract Amount: \$4,047,605.00
MBE Goal: 10.5%
WBE Goal: 10.5%
MBE Achieved: 0%
WBE Achieved: 16%

MBE SUBCONTRACTORS:
None

WBE SUBCONTRACTORS:
Name: Superior Moving Service, Inc.
Address: 2020 Walnut St.
Kansas City, MO 64108
Scope of Work: Receive / Transport / Installation of Seating
Dollar Amount: \$639,649
Ownership: Lynch, Ceil
Structure: Caucasian Female Code 27

Comments:

Attachment C: Prevailing Wage

Sec. 1. Attachments. The following documents are attachments to this contract and are attached hereto and incorporated herein by this reference:

Attachment A – Scope of Services

Attachment B – Schedule of Performance

Attachment C – Non-Construction Subcontractor Listing

Attachment D – Prevailing Wage Requirements

Annual Wage Order No. 28

County Platte

Work Type:

State – Building

Federal – Building

Division of Labor Standards Rules & Regulations

01290.03 Certified Payroll Instructions

01290.04 Certified Payroll Example

01290.05-06 Certified Payroll Report

01290.07 Payroll Certification

01290.08 Wage Rate Verification Questionnaire

01290.11 Daily Labor Force Report

01290.14 Contractor Affidavit for Final Payment

Attachment E – 00560 Missouri Project Exemption Certificate

00560.01 Kansas City Missouri Tax Exempt Certificate

Attachment F – 00620 Insurance Certificate

Missouri

Division of Labor Standards

WAGE AND HOUR SECTION



MICHAEL L. PARSON, Governor

Annual Wage Order No. 28

Section 083
PLATTE COUNTY

In accordance with Section 290.262 RSMo 2000, within thirty (30) days after a certified copy of this Annual Wage Order has been filed with the Secretary of State as indicated below, any person who may be affected by this Annual Wage Order may object by filing an objection in triplicate with the Labor and Industrial Relations Commission, P.O. Box 599, Jefferson City, MO 65102-0599. Such objections must set forth in writing the specific grounds of objection. Each objection shall certify that a copy has been furnished to the Division of Labor Standards, P.O. Box 449, Jefferson City, MO 65102-0449 pursuant to 8 CSR 20-5.010(1). A certified copy of the Annual Wage Order has been filed with the Secretary of State of Missouri.

Original Signed by _____

Taylor Burks, Director
Division of Labor Standards

Filed With Secretary of State: _____ **March 10, 2021**

Last Date Objections May Be Filed: **April 8, 2021**

Prepared by Missouri Department of Labor and Industrial Relations

OCCUPATIONAL TITLE	**Prevailing Hourly Rate
Asbestos Worker	\$67.59
Boilermaker	*\$30.80
Bricklayer	\$57.96
Carpenter	\$58.23
Lather	
Linoleum Layer	
Millwright	
Pile Driver	
Cement Mason	*\$30.80
Plasterer	
Communications Technician	\$60.15
Electrician (Inside Wireman)	\$64.42
Electrician Outside Lineman	\$70.22
Lineman Operator	
Lineman - Tree Trimmer	
Groundman	
Groundman - Tree Trimmer	
Elevator Constructor	*\$30.80
Glazier	*\$30.80
Ironworker	\$65.30
Laborer	\$46.07
General Laborer	
First Semi-Skilled	
Second Semi-Skilled	
Mason	*\$30.80
Marble Mason	
Marble Finisher	
Terrazzo Worker	
Terrazzo Finisher	
Tile Setter	
Tile Finisher	
Operating Engineer	\$58.47
Group I	
Group II	
Group III	
Group III-A	
Group IV	
Group V	
Painter	\$48.96
Plumber	\$71.21
Pipe Fitter	
Roofer	\$56.35
Sheet Metal Worker	\$69.50
Sprinkler Fitter	*\$30.80
Truck Driver	*\$30.80
Truck Control Service Driver	
Group I	
Group II	
Group III	
Group IV	

*The Division of Labor Standards received less than 1,000 reportable hours for this occupational title. Public works contracting minimum wage is established for this occupational title using data provided by Missouri Economic Research and Information Center.

**The Prevailing Hourly Rate includes any applicable fringe benefit amounts for each occupational title.

OCCUPATIONAL TITLE	**Prevailing Hourly Rate
Carpenter	\$59.33
Millwright	
Pile Driver	
Electrician (Outside Lineman)	*\$30.80
Lineman Operator	
Lineman - Tree Trimmer	
Groundman	
Groundman - Tree Trimmer	
Laborer	\$48.43
General Laborer	
Skilled Laborer	
Operating Engineer	\$56.35
Group I	
Group II	
Group III	
Group IV	
Truck Driver	\$48.91
Truck Control Service Driver	
Group I	
Group II	
Group III	
Group IV	

Use Heavy Construction Rates on Highway and Heavy construction in accordance with the classifications of construction work established in 8 CSR 30-3.040(3).

Use Building Construction Rates on Building construction in accordance with the classifications of construction work established in 8 CSR 30-3.040(2).

If a worker is performing work on a heavy construction project within an occupational title that is not listed on the Heavy Construction Rate Sheet, use the rate for that occupational title as shown on the Building Construction Rate Sheet.

*The Division of Labor Standards received less than 1,000 reportable hours for this occupational title. Public works contracting minimum wage is established for this occupational title using data provided by Missouri Economic Research and Information Center.

**The Prevailing Hourly Rate includes any applicable fringe benefit amounts for each occupational title.

OVERTIME and HOLIDAYS

OVERTIME

For all work performed on a Sunday or a holiday, not less than twice (2x) the prevailing hourly rate of wages for work of a similar character in the locality in which the work is performed or the public works contracting minimum wage, whichever is applicable, shall be paid to all workers employed by or on behalf of any public body engaged in the construction of public works, exclusive of maintenance work.

For all overtime work performed, not less than one and one-half (1½) the prevailing hourly rate of wages for work of a similar character in the locality in which the work is performed or the public works contracting minimum wage, whichever is applicable, shall be paid to all workers employed by or on behalf of any public body engaged in the construction of public works, exclusive of maintenance work or contractual obligation. For purposes of this subdivision, "overtime work" shall include work that exceeds ten hours in one day and work in excess of forty hours in one calendar week; and

A thirty-minute lunch period on each calendar day shall be allowed for each worker on a public works project, provided that such time shall not be considered as time worked.

HOLIDAYS

January first;
The last Monday in May;
July fourth;
The first Monday in September;
November eleventh;
The fourth Thursday in November; and
December twenty-fifth;

If any holiday falls on a Sunday, the following Monday shall be considered a holiday.

Attachment D: Bonds and Surety

Bonds and Surety. Contractor shall furnish a (If requiring “performance bond” select: “Performance and Maintenance Bond” or “Performance Bond”) to City on City furnished forms, executed by a Surety, in the amount of this Contract guaranteeing Contractor’s faithful performance of each and every term of this Contract and all authorized changes thereto and guaranteeing the services and work against faulty workmanship and faulty materials for the period of time as prescribed by the Bond. Surety must:

- A. Be approved by City’s Finance Department; and
- B. Be qualified to issue bonds at amounts specified in the Department of the Treasury Circular 570; and
- C. Be licensed by the State of Missouri to do business in the State of Missouri; and
- D. Retain an A.M. Best rating of “B+, Class V” for Bonds in excess of \$200,000.



PERFORMANCE BOND

Project Number _____

Project Title _____

KNOW ALL MEN BY THESE PRESENTS: That _____, as PRINCIPAL (CONTRACTOR), and _____, (SURETY), licensed to do business as such in the State of Missouri, hereby bind themselves and their respective heirs, executors, administrators, successors, and assigns unto Kansas City, Missouri, a constitutionally chartered municipal corporation, (OWNER), as obligee, in the penal sum of _____ Dollars (\$ _____) for the payment whereof CONTRACTOR and SURETY bind themselves, their heirs, executors, administrators, successors and assigns, jointly and severally, firmly by these presents.

WHEREAS,

CONTRACTOR has entered into a Contract with OWNER for _____ which Contract, including any present or future amendment thereto, is incorporated herein by reference and is hereinafter referred to as the Contract.

NOW, THEREFORE, THE CONDITION OF THIS OBLIGATION is such that, if CONTRACTOR shall promptly and faithfully perform said Contract including all duly authorized changes thereto, according to all the terms thereof, including those under which CONTRACTOR agrees to pay legally required wage rates including the prevailing hourly rate of wages in the locality, as determined by the Department of Labor and Industrial Relations or by final judicial determination, for each craft or type of workman required to execute the Contract and, further, shall defend, indemnify, and hold harmless OWNER from all damages, including but not limited to liquidated damages, loss and expense occasioned by any failure whatsoever of said CONTRACTOR and SURETY to fully comply with and carry out each and every requirement of the Contract, then this obligation shall be void; otherwise, it shall remain in full force and effect.

WAIVER. That SURETY, for value received, hereby expressly agrees that no change, extension of time, alteration or addition to the terms of the Contract or to the Work to be performed thereunder, shall in any way affect the obligations of this Bond; and it does hereby waive notice of any such change, extension of time, or alteration or addition to the terms of the Contract or the Work to be performed thereunder.

IN WITNESS WHEREOF, the above parties have executed this instrument the ____ day of _____, 20_____.

CONTRACTOR

Name, address and facsimile number of Contractor

I hereby certify that I have authority to execute this document on behalf of Contractor.

By: _____
Title: _____

(Attach corporate seal if applicable)

SURETY

Name, address and facsimile number of Surety:

I hereby certify that (1) I have authority to execute this document on behalf of Surety; (2) Surety has an A.M. Best rating of A- or better; (3) Surety is named in the current list of "Companies Holding Certificates of Authority as Acceptable Reinsuring Companies: as published in Circular 570 (most current revision) by the Financial Management Service, Surety Bond Branch, U.S. Department of the Treasury; and (4) Surety is duly licensed to issue bonds in the State of Missouri and in the jurisdiction in which the Project is located.

By: _____
Title: _____
Date: _____

(Attach seal and Power of Attorney)



PAYMENT BOND

Project Number _____

Project Title _____

KNOW ALL MEN BY THESE PRESENTS: That _____, as PRINCIPAL (CONTRACTOR), and _____, (SURETY), licensed to do business as such in the State of Missouri, hereby bind themselves and their respective heirs, executors, administrators, successors, and assigns unto Kansas City, Missouri, a constitutionally chartered municipal corporation, (OWNER), as obligee, in the penal sum of _____ Dollars (\$_____) for the payment whereof CONTRACTOR and SURETY bind themselves, their heirs, executors, administrators, successors and assigns, jointly and severally, firmly by these presents.

WHEREAS,

CONTRACTOR has entered into a contract with OWNER for _____, which Contract, including any present or future amendment thereto, is incorporated herein by reference and is hereinafter referred to as the Contract.

NOW, THEREFORE, THE CONDITION OF THIS OBLIGATION is such that, if in connection with the Contract, including all duly authorized modifications thereto, prompt payment shall be made to all laborers, subcontractors, teamsters, truck drivers, owners or other suppliers or for equipment employed on the job, and other claimants, for all labor performed in such work whether done for CONTRACTOR, a subcontractor, SURETY, a completion contractor or otherwise (at the full wage rates required by any law of the United States or of the State of Missouri, where applicable), for services furnished and consumed, for repairs on machinery, for equipment, tools, materials, lubricants, oil, gasoline, water, gas, power, light, heat, oil, telephone service, grain, hay, feed, coal, coke, groceries and foodstuffs, either consumed, rented, used or reasonably required for use in connection with the construction of the work or in the performance of the Contract and all insurance premiums, both for compensation and for all other kinds of insurance on the work, for sales taxes and for royalties in connection with, or incidental to, the completion of the Contract, in all instances whether the claim be directly against CONTRACTOR, against SURETY or its completion contractor, through a subcontractor or otherwise, and, further, if CONTRACTOR shall defend, indemnify and hold harmless OWNER from all such claims, demands or suits by any such person or entity, then this obligation shall be void; otherwise, it shall remain in full force and effect.

Any conditions legally required to be included in a Payment Bond on this Contract, including but not limited to those set out in §107.170 RSMo. are included herein by reference.

SURETY agrees that, in the event that CONTRACTOR fails to make payment of the obligations covered by this Bond, it will do so and, further, that within forty-five (45) days of receiving, at the address given below, a claim hereunder stating the amount claimed and the basis for the claim in reasonable detail, it (a) will send an answer to the claimant, with a copy to OWNER stating the amounts that are undisputed and the basis for challenging any amounts that are disputed, and (b) will pay any amounts that are undisputed. The amount of this Bond shall be reduced by and to the extent of any payment or payments made in good faith hereunder.

While this Bond is in force, it may be sued on at the instance of any party to whom any such payment is due, in the name of OWNER to the use for such party. OWNER shall not be liable for the payment of any costs or expenses of any such suit.

No suit shall be commenced or pursued hereunder other than in a state court of competent jurisdiction in Jackson, Clay or Platte County, Missouri, or in the United States District Court for the Western District of Missouri.

WAIVER. That SURETY, for value received, hereby expressly agrees that no change, extension of time, alteration or addition to the terms of the Contract or to the Work to be performed thereunder, shall in any way affect the obligations of this Bond; and it does hereby waive notice of any such change, extension of time, or alteration or addition to the terms of the Contract or the Work to be performed thereunder.

IN WITNESS WHEREOF, the above parties have executed this instrument the _____ day of _____, 20_____.

CONTRACTOR

Name, address and facsimile number of Contractor

I hereby certify that I have authority to execute this document on behalf of Contractor.

By: _____
Title: _____

(Attach corporate seal if applicable)

SURETY

Name, address and facsimile number of Surety:

I hereby certify that (1) I have authority to execute this document on behalf of Surety; (2) Surety has an A.M. Best rating of A- or better; (3) Surety is named in the current list of "Companies Holding Certificates of Authority as Acceptable Sureties on Federal Bonds and as Acceptable Reinsuring Companies" as published in Circular 570 (most current revision) by the Financial Management Service, Surety Bond Branch, U.S. Department of the Treasury; and(4) Surety is duly licensed to issue bonds in the State of Missouri and in the jurisdiction in which the Project is located.

By: _____
Title: _____
Date: _____

(Attach seal and Power of Attorney)



Sole Brand Waiver Kansas City Code Section 3-7

DATE: June 29, 2021

TO: Pat Klein, Director of Aviation Department
Keely Golden, Procurement Manager

^{DS}
pk

FROM: Ian Redhead, Deputy Director of Operations and Maintenance

^{DS}
IR

SUBJECT: Sole Brand Procurement from Arconas Furniture

It is recommended that in accordance with Code Section 3-3, the solicitation requirements of Code Section D number 5 to enter into a piggyback contract with Arconas Furniture based on their GSA contract GS-27F-018GA for additional seating in the new OneTerminal, as it is necessary to provide essential services or meet city contractual obligations.

The Aviation Department is requesting to mark a sole brand designation for Arconas Furniture. “The new terminal hold room design requires a total of 4,924 passenger seats. The Aviation department decided to purchase the Arconas Flyaway seats for the hold rooms because the airport currently has 1,000 existing Flyaway seats with the same color seats purchased in two 2017 purchases. This decision, including the addition of new power models, cup holders and cable management, was a saving of \$714,692 on this purchase. The Flyaway benches, that are necessary for the recompose areas at the security checkpoint, were chosen as they are part of the same family series as the hold room seats.”

The estimated total for this contract is \$4,047,605 including all furniture and services. The contract will be multi-year and match the GSA schedule term. Phase 1 includes the purchase of the furniture, peripherals and warranty. Phase 2 includes the installation and ancillary services. MWBE goals are in the process of being established for the Phase 2 portion.

If you have any questions, please contact Ian Redhead at 816-243-3100.

DocuSigned by:
Darrell Everette
DE6901B73458419

6/29/2021

Darrell Everette, Acting Procurement Services Manager

Date

CC: Department Director
Keely Golden, Procurement Manager

GSA PRICE LIST

VERSION: MAY 2021

GENERAL SERVICES ADMINISTRATION FEDERAL SUPPLY SERVICE

Authorized Federal Supply Schedule
Catalogue & Pricelist

Furniture & Furnishing – Office Furniture
MAS – Multiple Award Schedule
Commodity: Furniture
Standard Industry Group: 337214 (NAICS)

Contract Number: GS-27F-018GA

For more information on ordering from Federal Supply Schedules click
on the FSS Schedules button at fss.gsa.gov

Contract Period: March 23, 2017 - March 22, 2022

Modification No: PS-0017

Effective Date 07/14/2020

Contractor Name and Ordering Address:

**ARCONAS Corporation
5700 Keaton Crescent**

**Mississauga, Ontario
Canada L5R 3H5**

Phone: +1 (800) 387-9496

Fax: +1 (905) 897-7470

www.arconas.com

Business Size: Other than small
Prices shown are Net (Discount deducted)

On-line access to contract ordering information, terms and conditions,
up-to-date pricing, and the option to create an
electronic delivery order is available through GSA Advantage!,
a menu-driven database system. The internet address for
GSA Advantage! is: <http://www.gsaadvantage.gov>.

ARCONAS

information for ordering activities

FSC Group 71

FSC Class/Product Code: 71

- 1a Awarded Special Item Number:
711-17 Multiple Seating (Beam and Platform Seating)
- 1b Lowest price model per SIN:
711-17 Model SET setz single seat unit \$307
- 1c Hourly Rates: Non Applicable
- 2 Maximum Order: \$200,000
- 3 Minimum Order: \$100.00
- 4 Geographic Coverage: 48 Contiguous States and the District of Columbia
- 5 Production Point: Mississauga, Ontario, Canada (City of Toronto)
- 6 Pricing Provided is NET
- 7 Quantity Discounts from Net Pricing:
- | | | | | |
|-----------|---|---------------|---|----|
| \$25,000 | - | \$50,000 | - | 1% |
| \$50,001 | - | \$75,000 | - | 2% |
| \$75,001 | - | \$100,000 | - | 3% |
| \$100,001 | - | \$150,000 | - | 4% |
| \$150,001 | - | Maximum Order | - | 5% |
- 8 Prompt Payment Terms: Net 30 days.
- 9a Government Purchase Card is accepted at or below the micro-purchase threshold.
- 9b Government Purchase Card is accepted at or above the micro-purchase threshold.
- 10 Foreign Items: All items produced in Canada
- 11a Time of Delivery: 90 days or less ARO
- 11b Expedited Delivery: None
- 11c Overnight and 2nd day delivery: None
- 11d Urgent Requirements: Call customer service
- 12 FOB Point: Mississauga, ON Canada
- 13a Ordering Address:
- ARCONAS Corporation**
5700 Keaton Crescent
Mississauga Ontario L5R 3H5 Canada
Phone: +1 (800) 387-9496
Fax: +1 (905) 897-7470
- 13b Ordering Procedures:
For supplies and services, the ordering information on Blanket Purchase Agreements (BPA's), are found in Federal Acquisition Regulation (FAR) 8.405-3
- 14 Payment Address: Same as #13a above.
- 15 Warranty: See attached "Warranty"
- 16 Export Packing Charges: Contact Customer Service for pricing
- 17 Terms & conditions of Government purchase card acceptance: None.

information for ordering activities

- 18 Terms & conditions of rental, maintenance and repair: n/a
- 19 Terms & conditions of installation: n/a
- 20 Terms & conditions of repair parts: n/a
- 20a Terms & conditions for any other services: n/a
- 21 List of service and distribution points: n/a
- 22 List of participating dealers: see attached, call customer service for any recent updates
- 23 Preventative Maintenance: n/a
- 24 Environmental attributes: See attached "Arconas and the Environment"
- 25 Data Universal Number System (DUNS) number: 207040551
- 26 Arconas Corporation is registered in the Central Contractor Registration (CCR) database

Government Restocking>Returns: The restocking charge will not exceed 25% of the net cost for items returned for other than warranty reasons. Agencies must notify the contractor for authorization prior to returning any items.

Government Cancellation Policy: Cancellations: Client will not be charged for any cancellation if order is canceled in writing to Arconas Corporation prior to start of production or purchase of special fabric. If production is in process, client will only be charged costs incurred that cannot be recovered within a reasonable length of time (6 months).

table of contents

general information		alphabetical		categorical	
information for ordering activities	1	aerea™	10	<u>public and modular</u>	9
table of contents	3	bernù® aero	18	aerea™	10
the arconas commitment	4	bernù® aero wood	22	bernù® aero	18
terms of sale	5	bernù® aero poly	24	bernù® aero wood	22
warranty	8	bernù® aero wood/poly	26	bernù® aero poly	24
		bernù® bench	28	bernù® aero wood/poly	26
		bikerax	68	bernù® bench	28
		connex	52	flyaway	31
		datum	61	flyaway bench	35
		flyaway	31	place®	39
		flyaway bench	35	setz™	44
		inPower™ bar	64	morelli bench	50
		inPower™ flex	65		
		morelli bench	50	<u>lounge</u>	51
		place®	39	connex	52
		setz™	44	datum	61
		twenty-twenty	62	twenty-twenty	62
		x series	69		
				<u>power</u>	63
				inPower™ bar	64
				inPower™ flex	65
				<u>waste, recycling, and outdoor</u>	67
				bikerax®	68
				x series	69
				x series trashbox®	72
				x series super trashbox®	73
				x series rux® II, III & IV	74
				x series smokestax®	75
				x series graph-x	76
				x series lin-x	77

ARCONAS

5700 Keaton Crescent
Mississauga, Ontario
Canada L5R 3H5

Telephone: +1-905-272-0727

Toll Free: +1-800-387-9496

Fax: +1-905-897-7470

arconas.com

1-800-387-9496

07.20

ARCONAS

GSA Price List - 03

ARCONAS commitment

our vision To be the world's authority in furniture for public spaces.

our mission Arconas defines what high design and high performance are all about. We build public seating that is elegant, comfortable and durable. And we build it with a commitment to excellence and environmental stewardship.

our values We respect, appreciate and value everyone.
We maintain a strong tradition of innovation.

Arconas has practiced environmentally responsible operations since we began manufacturing in 1972.

All of our public seating lines meet the requirements of the ANSI/BIFMA Emissions Standards X7.1.2011. Our beam-based products are low VOC and do not contribute to poor indoor air quality.

The MDF we use is made from recycled/recovered wood fibers rather than using new wood. We also have available a formaldehyde-free MDF option. Many of our upholstery choices are made of recycled fibers. When new wood is used in our table tops, Forest Stewardship Council (FSC) certified wood options are available.

Arconas and the environment Arconas is fully committed to reduce waste, reuse materials and recycle wherever possible to minimize landfill contributions.

terms of sale

Unless otherwise agreed to in writing between Arconas Corporation ("Arconas") and the recipient of Arconas' quotation (the "Customer") for the sale of products (the "Products") the following terms: (a) are part of Arconas' quotation for the sale of Products and acceptance by Arconas of any resulting order from the Customer (the "Order"); (b) shall become the exclusive and binding agreement between Arconas and the Customer with respect to the Order (the "Agreement"); and (c) shall apply to any purchase order issued by the Customer in connection with an Order, regardless of whether these terms are expressly referenced in that purchase order. No term set forth in any of the Customer's form of solicitation, purchase order, or contract shall become part of the Agreement or otherwise become binding on Arconas unless expressly agreed to in writing by Arconas.

standard terms of sale

change orders

Substitutions, deletions, additions or other changes to an Order may not be made by a Customer without the written approval of Arconas. A \$500 change fee will apply to all confirmed orders once they have been acknowledged by Arconas.

The purchase price for the Products as described in Arconas' quotation is F.O.B. Arconas' factory (the "Purchase Price"). Payment terms shall be as described in Arconas' quotation.

If any undisputed amount payable by the Customer under this Agreement is not paid when due, Arconas may assess and, if so assessed, the Customer shall pay a late charge at the rate of twelve percent (12%) of the outstanding amount (or at highest rate permitted by law, whichever is lower), per annum, pro rated on a daily basis. If an invoiced item is disputed, the Customer must give Arconas written notice of such dispute with full particulars thereof within thirty (30) days after the Customer's receipt of the applicable invoice. If the Customer disputes an invoiced item and such invoiced item is upheld in Arconas' favour, then such late payment charge provided for herein shall apply to the time period starting ten (10) days from the date on which the dispute is resolved. If the invoice contains an error, the Customer shall notify Arconas of such error and late charges shall apply thirty (30) days after the Customer's receipt of a corrected invoice.

Unless expressly provided for in Arconas' quotation and the Order, the Purchase Price does not include any applicable taxes, duties or other assessments that are applicable to the Order. The Customer shall pay any applicable taxes, duties or other assessments of a governmental authority and related interest and penalties relating to the Order (excluding taxes on Arconas' income). The Customer shall forthwith provide Arconas with copies of any documents which are reasonably requested by Arconas to evidence the remittance of any taxes, duties or other assessments relating to the self-assessment and remittance of taxes, duties or other assessments paid by the Customer relating to an Order. The Customer shall indemnify and save Arconas and Arconas' directors harmless from any taxes, duties, assessments, penalties, interest or other amounts which may be payable by or assessed against Arconas or its directors as a result of or in connection with the Customer's failure to pay in full when due all taxes, duties or other assessments relating to an Order.

prices, payment and taxes

A Customer may not cancel any order without Arconas' approval and then only upon payment of the applicable cancellation charges set forth herein. The effective date of any approved cancellation shall be the date that Arconas receives notice from the Customer of its request to cancel an order (the "Cancellation Date"). Cancellation charges shall be assessed as follows: (i) for orders scheduled to ship within ten (10) days of the Cancellation Date, cancellation charges shall be one hundred percent (100%) of the Purchase Price; (ii) for shipments scheduled beyond ten (10) days from the Cancellation Date, cancellation charges shall be fifty percent (50%) of the Purchase Price. Arconas is under no obligation to accept any order cancellation and may refuse any Customer request for cancellation in Arconas' sole discretion. In the event of an approved cancellation, Arconas shall have the right to retain any funds paid in the form of a progress or deposit payment, as applicable, towards satisfaction of a cancellation charge payable hereunder.

cancellation

The occurrence of any one of the following events before payment in full is received by Arconas shall be an "Event of Default": (a) the Customer fails to make a payment when due and payable; (b) the Customer fails or neglects to perform any of its obligations hereunder; (c) the Customer makes any false or misleading representation to Arconas in connection with this Agreement; (d) the Customer enters into any arrangement with its creditors or any of them or suspends payment generally or is otherwise unable to pay its debts as they become due; (e) a receiver for the Customer or any material portion of its property is appointed or steps are taken for the appointment of such receiver by any person or entity; (f) if a bankruptcy, liquidation, insolvency or other similar proceeding is filed by or against the Customer, and in the case of an involuntary proceeding, is not vacated or set aside within sixty (60) days of its commencement; or (g) a breach or default by the Customer occurs under any other agreement between the Customer and Arconas or with respect to any other obligation of the Customer to Arconas. Upon the occurrence of an Event of Default, in addition to any other remedies available to Arconas under this Agreement or at law, Arconas shall have the right to terminate this Agreement and retain any funds paid in the form of a progress or deposit payment, as applicable, towards satisfaction of any expenses, costs, damages or other liabilities incurred by Arconas related to the Event of Default.

events of default

So long as any amount of the Purchase Price and any other charges payable hereunder in connection with an Order remain outstanding, title to the Products shall remain with Arconas. Arconas hereby retains and the Customer hereby grants to Arconas a security interest in the Products purchased hereunder until the Customer has made payment in full for the Products. The Customer shall execute, deliver or endorse any and all instruments, documents, assignments, security agreements and other agreements and writings that Arconas may at any time reasonably request in order to secure, protect, perfect or enforce the security interest and Arconas' rights under this Agreement. Arconas shall have all of the rights of a secured party with respect to the Products purchased hereunder under applicable laws. Upon the Customer's default of any payment obligation, in addition to other rights and remedies it has under this Agreement and may have at law, Arconas may exercise all the rights and remedies of a secured party in respect of the Products on default under applicable law, including, without limitation, the right to enforce the security interest to retake possession of any or all of the Products. Upon payment of the Purchase Price and all other charges payable by the Customer in connection with an Order, title to the Products shall transfer to the Customer and the security interest granted hereunder to Arconas shall be discharged.

title to products and arconas security interest

The Customer shall indemnify, defend and hold Arconas harmless from and against any and all claims, actions, losses, damages, demands, liabilities, costs and expenses, including reasonable attorney's fees and expenses, whether or not a suit or other proceeding is initiated, which may arise from, but not limited to, the following events: (i) representations or misrepresentations made by the Customer, (ii) any neglect by the Customer or end-users, (iii) the Customer's or end-users' use of the Products not in compliance with the Products' intended purposes, (iv) installation of the Products by the Customer is not in accordance with Arconas' installation guidelines, (v) Customer's or end-users' modifications or alterations of Products that have not been approved by Arconas, (vi) damage from Customer or end-user misuse of the Products, or (vii) any other act, or failure to act, not in accordance with the terms of this Agreement by the Customer, or any other breach by the Customer of any covenants of the Customer under this Agreement.

indemnification

This Agreement shall be governed by and construed in accordance with the laws of the Province of Ontario, Canada. The application of the United Nations Convention for the International Sale of Goods is excluded and shall not apply to any purchase and sale made hereunder. Any legal suit or action arising out of or relating to this Agreement may be instituted in a court of competent jurisdiction in Ontario, Canada and the Customer waives any objection which it may now otherwise have or hereafter have to the waiving of the venue of any such suit, action or proceeding and hereby subjects itself to the jurisdiction of any such court.

governing law; consent to jurisdiction

terms of sale

assignment

The Customer may not assign, transfer or otherwise encumber this Agreement or any part thereof without express written consent of Arconas. Arconas may assign and transfer this Agreement or any interest or right hereunder or any interest or right in the Products and/or grant a security interest in the Products, in whole or in part. Subject to the foregoing, this Agreement shall inure to the benefit of, and is binding upon, the successors and permitted assigns of the parties.

force majeure

A party's obligations hereunder will be excused during any time period when it is unable to perform such obligations hereunder due to circumstances beyond its reasonable control, including but not limited to fire, flood, embargoes, war, strikes, lockouts or other labour disturbances, shortages of labour or materials, acts of God, omissions or delays in acting by any governmental authority or other party. The party so affected, upon giving prompt written notice to the other party, shall be excused from performance of its obligations hereunder to the extent of the during of such event provided that such party shall use its reasonable commercial efforts to avoid or remove such event.

entire agreement

The Customer's acceptance of any Products purchased under this Agreement shall be deemed acceptance of all the terms and conditions stated herein. Arconas' failure to object to any provisions contained in any communication from the Customer shall not be deemed a waiver of the provisions contained herein. This Agreement represents the entire agreement between the parties relating to the subject matter hereof and shall supersede all prior written or oral understandings and/or other terms in any purchase order or other document, now or hereafter delivered, except that this Agreement shall not supersede other written agreements between the parties that expressly reference this Agreement.

warranty

At Arconas we are proud of the products we manufacture. We confidently warranty our products against defects in material and workmanship when properly installed, maintained and used for their intended purposes.

The Arconas warranty extends for 10 years from date of manufacture to the original purchaser for products used on a single shift (8 hours) basis. Products with higher usage will be covered for 5 years. Electrical components against defects in parts and workmanship as for a period of 1 year from the date of the initial installation.

Arconas will provide field repair or replacement of warranted parts free of charge during the first year of a warranty. Thereafter, Arconas will replace defective parts for our customer to install.

Arconas products are designed to provide long service under normal use; damage resulting from misuse, abuse, negligence or accident are not covered. While serviceability will be maintained, we cannot prevent normal wear and tear, colour and texture change.

warranty

Arconas shall not be held liable for consequential, economic or incidental damages arising from any product defect.

freight

Freight terms shall be as described in the Order.

Customers should refuse shipments showing visible damage. Where concealed damage is discovered customers should immediately notify the transportation company. Any claims must be directed to the transportation company. Arconas' responsibility ceases at point of pick up by the carrier at our facility. Claims must originate at point of delivery.

COM materials are to be sent prepaid to **Arconas, 5700 Keaton Crescent, Mississauga, ON Canada L5R 3H5**. The packing slip accompanying the shipment must show the client's name and purchase order number to which the material is to be applied as well as the yardage shipped, fabric content and value. Also, a sample of the fabric must be enclosed with the packing slip. This information is mandatory for Customs purposes.

NOTE: The client is responsible for paying Duties and Taxes, plus freight charges incurred by commercial couriers.

A sample of the COM material must be supplied directly from the customer prior to the time of order to allow Arconas to assess suitability and to ensure accurate requirements. The Arconas warranty does not apply to COM material. A surcharge will apply for any material requiring special handling. Arconas reserves the right to refuse any fabric not considered suitable for our products. The customer will be notified before cutting if any COM material or pattern is deemed unsuitable for a product. Inquire with the factory for warranty of COM fabrics.

fabrics

Yardage given throughout the price list is based on 54" wide material without pattern. For a patterned fabric, please inquire with the factory.

California technical bulletin 133 is a flammability test procedure for seating furniture for use in public occupancies. The "all components" test requires that a product be tested in the finished form, in which it will be used within an installation. The code requires that a product "does not support combustion."

Arconas is able to alter our standard foam to pass CAL133. Call Customer Service for applicable products and pricing.

CAL 133

NOTE: When product is required to pass CAL133 insure that the fabric selected will also be able to pass this test.

public and modular

aerea™

bernù® aero metal

bernù® aero wood

bernù® aero poly

bernù® aero wood/poly

bernù® bench

flyaway

place®

setz™

ARCONAS

aerea™ lounge product map

designer douglas ball

public and modular

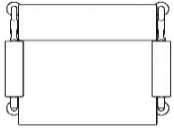

armchair



loveseat

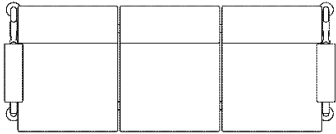

sofa



lounge units

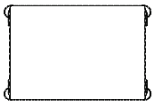

ottoman

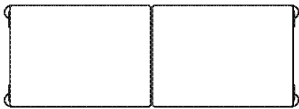

two seat bench

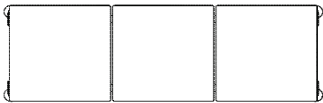

three seat bench

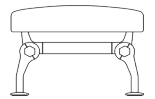

bench units



coffee table

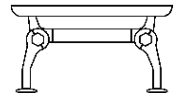

table

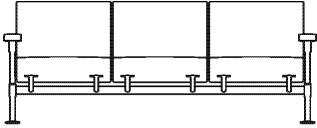
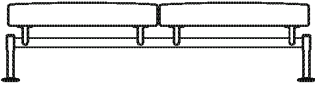
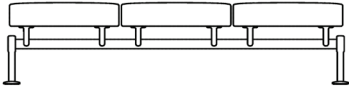
Model No.	C.O.M.	A	B	C	D	E	F	G	H
 <p>AERS30A w33" d29" h32" sh17.5" ah23"</p>	898	898	927	956	986	1015	1044	1073	1102
<p>2.5 yds armchair (30" seat with polyurethane arms) shipping 75 lbs.</p>									
 <p>AERLOVE w64" d29" h32" sh17.5" ah23"</p>	1593	1593	1657	1722	1785	1850	1914	1978	2043
<p>5.5 yds loveseat (30" seats with polyurethane arms at ends) shipping 150 lbs.</p>									
 <p>AERSOFA w71" d29" h32" sh17.5" ah23"</p>	2128	2128	2198	2268	2338	2408	2478	2549	2618
<p>6 yds sofa (22" seats with polyurethane arms at ends) shipping 200 lbs.</p>									
 <p>AEROTT30 w31" d25" sh17.5"</p>	535	535	552	570	587	605	622	640	657
<p>1.5 yds ottoman (30" seat) shipping 50 lbs.</p>									
 <p>AER2B w62" d25" sh17.5"</p>	1070	1070	1105	1140	1175	1210	1245	1280	1315
<p>3 yds two seat bench (30" seats) shipping 100 lbs.</p>									
 <p>AER3B w68" d25" sh17.5"</p>	1444	1444	1496	1548	1601	1654	1706	1759	1811
<p>4.5 yds three seat bench (22" seats) shipping 150 lbs.</p>									

SEATING COMPONENTS

Choose from 22" and 30" seat widths; intermediate, end, and connecting tables; and arms to create customized configurations. *Maximum beam length for a unit is 144" / 3657mm.* Beam lengths exceeding 72" / 1829mm requires a center leg.

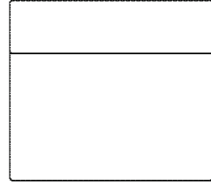
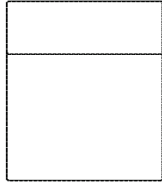

22" seat
AERS22
w22" x d29"

30" seat
AERS30
w30" x d29"

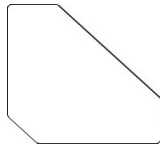

90° connecting table
AERTABCON
w34" x d34"

13" in-line / end table
AERTAB13
w13" x d24"

22" in-line / end table
AERTAB22
w22" x d24"

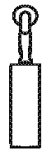

leg set (front + back)
AERLEGS
w1 1/2" x d8"

arm
AERARMU
w4" x d15"



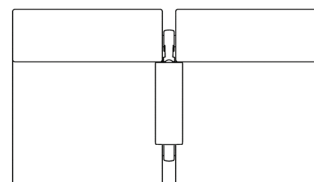
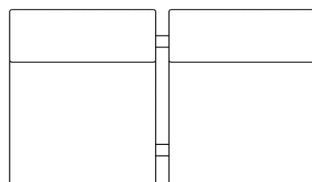
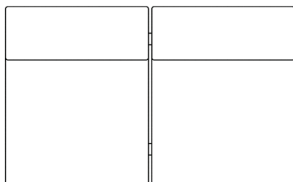

STANDARD GAP BETWEEN CUSHIONS

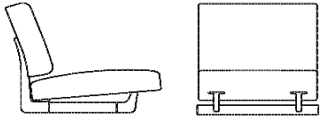
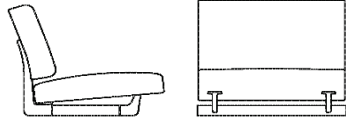

lounge seating - no gap

custom units - 1 7/8" gap

custom units with arms - 1 7/8" gap

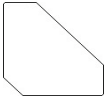
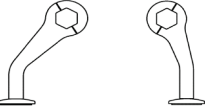
Model No.	C.O.M.	A	B	C	D	E	F	G	H						
 <p>AERS22 w25" d29" h32" sh17.5" 22" seat</p>	642	642	665	688	712	735	759	782	805						
2 yds															
shipping 65 lbs.															
 <p>AERS30 w33" d29" h32" sh17.5" 30" seat</p>	695	695	724	753	783	812	841	870	899						
2.5 yds															
shipping 75 lbs.															
 <p>AERARMU w4" d15" ah23" arm rest with polyurethane pad</p>	80														
shipping 5 lbs.															
 <p>AERTAB13 w13" d24" 13" in-line /end table</p>	<table border="1"> <thead> <tr> <th>Laminate</th> <th>Veneer</th> <th>Solid Surface / Granite</th> </tr> </thead> <tbody> <tr> <td>313</td> <td>422</td> <td>529</td> </tr> </tbody> </table>		Laminate	Veneer	Solid Surface / Granite	313	422	529							
Laminate	Veneer	Solid Surface / Granite													
313	422	529													
shipping 10 lbs.															
 <p>AERTAB22 w22" d24" 22" in-line /end table</p>	422	529	743												
shipping 15 lbs.															
 <p>AERTABCON w34" d34" 90° connecting table</p>	529	637	850												
shipping 25 lbs.															
 <p>AERLEGS legs for bariatric chair (front + back)</p>	set	101													
shipping 3 lbs.															

BENCH COMPONENTS

Choose from 22" and 30" seat widths to create customized bench configurations.

Maximum beam length for a bench unit is 144" / 3657mm. Beam lengths exceeding 72" / 1829mm requires a center leg.

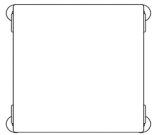
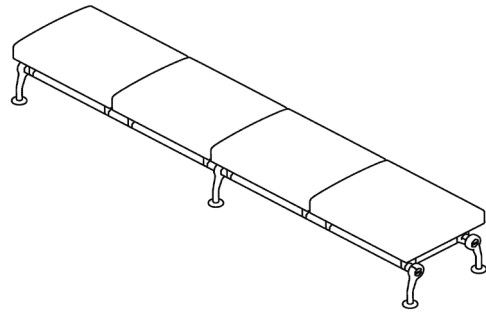

22" ottoman

30" ottoman

STANDARD GAP BETWEEN CUSHIONS

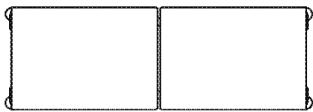

lounge bench units - no gap

custom bench units - 1 7/8" gap is optional

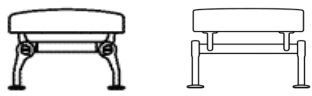
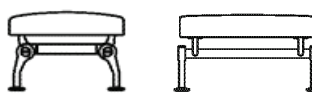
Model No.	C.O.M.	A	B	C	D	E	F	G	H
 AEROTT22 w23" d25" sh17.5"	481	481	493	504	516	528	540	551	563
	1 yd	ottoman (22" seat)							shipping 43 lbs.
 AEROTT30 w31" d25" sh17.5"	535	535	552	570	587	605	622	640	657
	1.5 yds	ottoman (30" seat)							shipping 50 lbs.

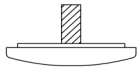

43

GLIDE-FLOOR

dia3"

floor mounting glides, set of 2 (upcharge)

shipping .5 lb.



set of four 79

GLIDE-NONSLIP

dia3"

non-slip glide for hard floors (upcharge)

shipping 1 lb.

construction

Legs, Back Supports and Arms

- Die cast aluminum

Beams and End Caps

- 1.842" hexagonal shape
extruded aluminum

Seat and Back

- Polyurethane foam moulded over
welded steel frames

Foam

- Injected moulded CFC free,
fire retardant HR urethane with
BiOH Polyols

finish

Aluminum

- Powder coat
 - Cloud Silver
 - Textured Black
 - Custom colours available
- Minimum quantities apply.

tables

- Standard Arconas
laminates w/ vinyl edge
- Standard Arconas
solid surface & granite

to order specify

- Model number
- Powder coat finish
- Fabric
- Layout

CUSTOM CONFIGURATION EXAMPLES illustrate beam length calculations.

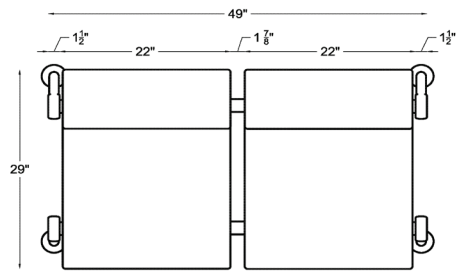

ex. 1 : Two seat unit with gap. Beam length 49" / 1245 mm.

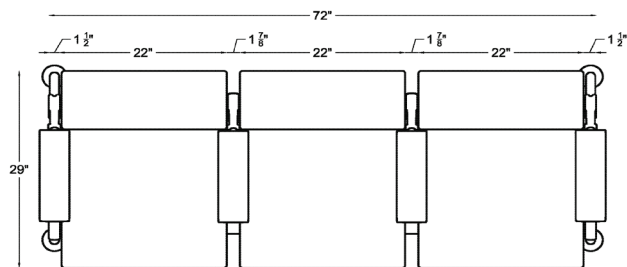

ex. 2 : Three seat unit with arms at every seat position. Beam length 72" / 1829 mm.

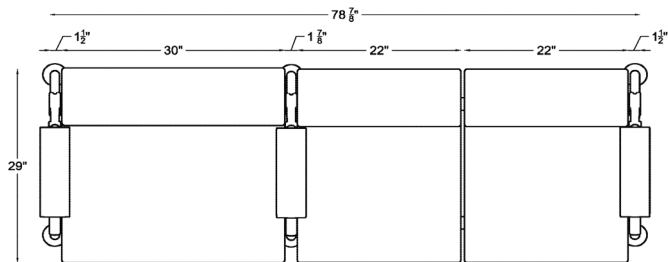

ex. 3 : **Bariatric** applications require legs to be positioned on both sides of the seat. Reference page 11 for leg price. Beam length 78 7/8" / 2003 mm.

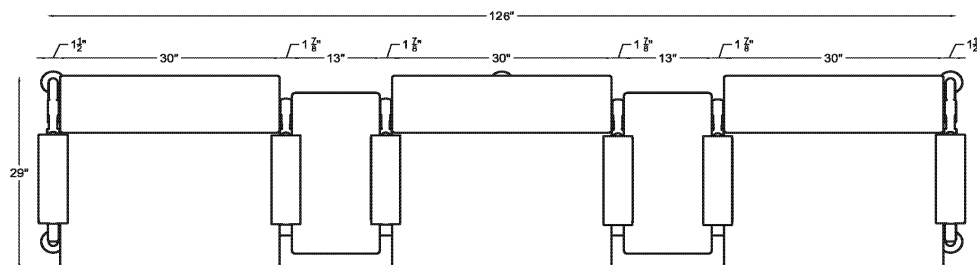

ex. 4 : Three seat unit with arms and 13" intermediate tables. Beam length 125" / 3175 mm.

This page illustrates pricing for custom configurations. Component prices (page 11) are used to calculate any configuration that is not an Arconas standard lounge unit.

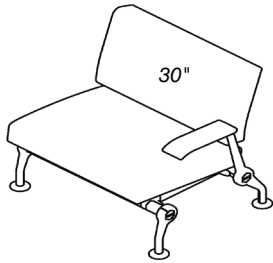

Config 1 : 30" seat unit with arm, grade A fabric.

AERS30 + AERARMU
 $695 + 80 = \$775$

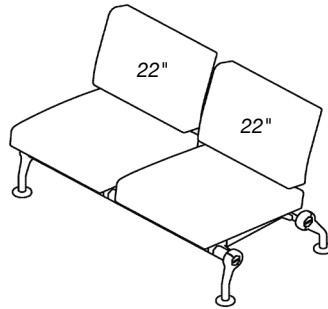

Config 2 : 22" seat units with gap between seats; no arms, grade C fabric.

AERS22 + AERS22
 $688 + 688 = \$1376$

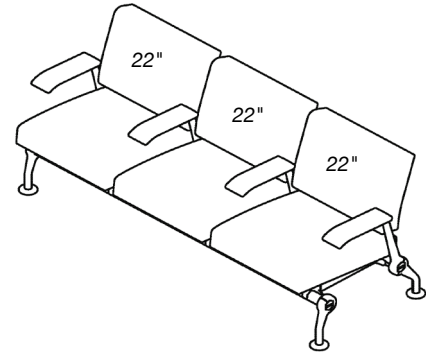

Config 3 : 22" seat units with arms, grade G fabric.

(AERARMU x 4) + (AERS22 x 3)
 $(80 \times 4) + (782 \times 3) =$
 $320 + 2346 = \$2666$

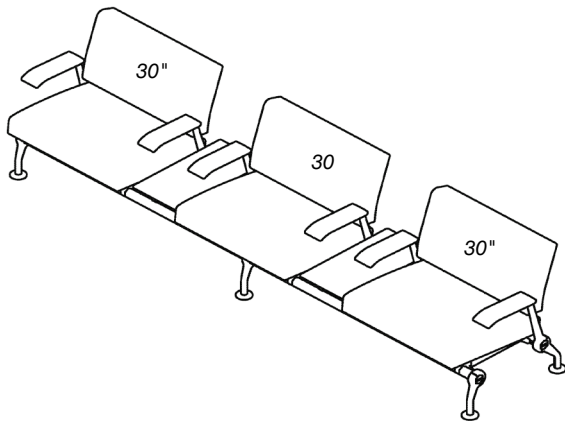

Config 4 : 30" seat units with arms and 13" laminate inline tables with extra leg set, grade B fabric.

(AERARMU x 6) + (AERS30 x 3) + (AERTAB13 x 2) + AERLEGS
 $(80 \times 6) + (724 \times 3) + (313 \times 2) + 101 =$
 $480 + 2172 + 626 + 101 = \3379

bernù® aero series product map

metal + wood + poly + wood/poly combo + bernù bench
designer davide tonizzo

public and modular

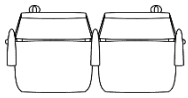

two seat unit

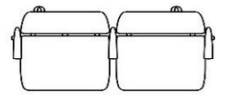

wide two seat unit

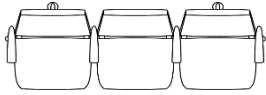

three seat unit

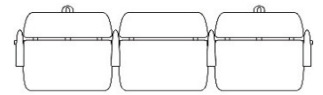

wide three seat unit

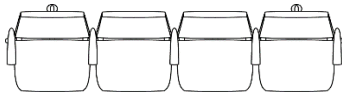

four seat unit



Accessibility embroidery options

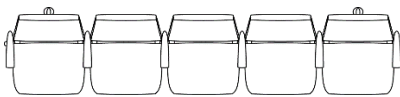

five seat unit



linear units

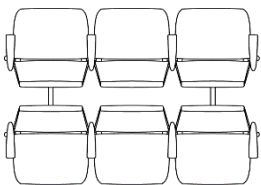

two to five seat units per side



back to back linear units



inside curve unit (inc. wedge table)



outside curve unit



curved units

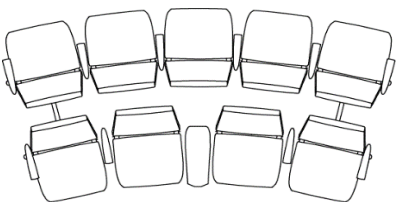

inside and outside curved units, back to back



back to back curved units



21" table, can be located at any seat position

table

bernù® aero series configurations

metal + wood + poly + wood/poly combo + bernù bench
designer davide tonizzo

public and modular

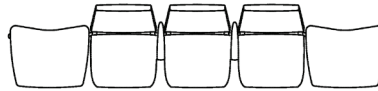
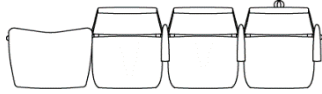
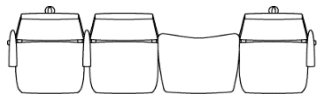

21" table, can be located at any seat position

linear and curved units can accommodate more than one table

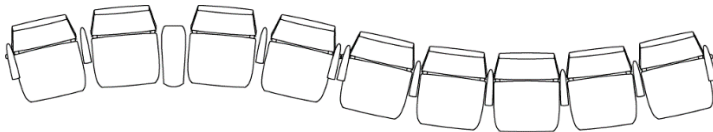

inside + outside curved units

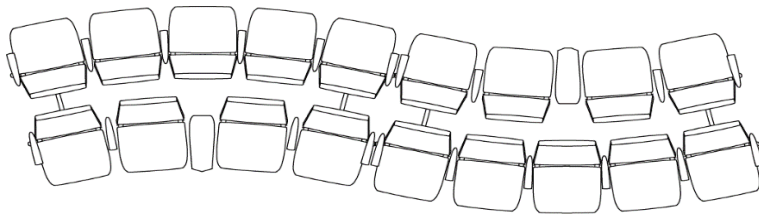

inside + outside curved units, back to back

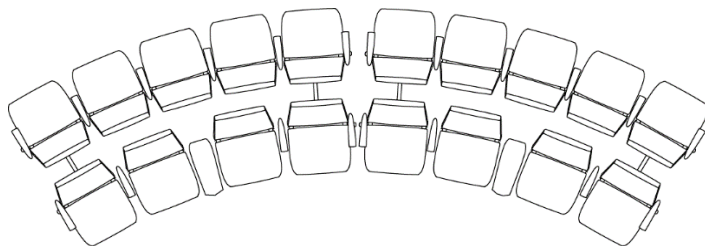

inside + outside curved units, back to back

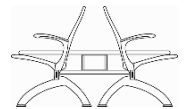
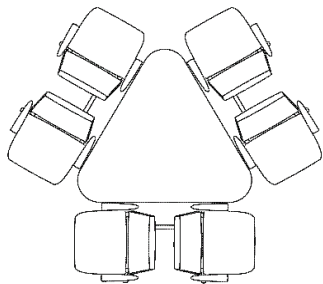

cluster units

cluster

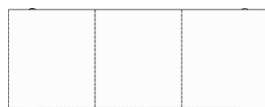

wood

upholstered

bench

Model No.	C.O.M.	A	B	C	D	E	F	G	H
-----------	--------	---	---	---	---	---	---	---	---

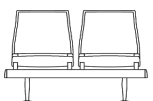
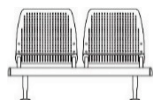

Unit price includes seats only.

Perforated Metal (No Upholstery)	780								
Seat + Back Pads	968	968	991	1014	1038	1061	1084	1108	1131
	2 yds								

BA2SM

w49" d28.5" h33" sh17"

two seat unit, metal seat and back with upholstered pads shipping 104 lbs.

Perforated Metal	1019								
Seat + Back Pads	1297	1297	1333	1367	1402	1437	1473	1508	1542
	3 yds								

BA3SM

w72" d28.5" h33" sh17"

three seat unit, metal seat and back with upholstered pads shipping 170 lbs.

Perforated Metal	1294								
Seat + Back Pads	1664	1664	1710	1757	1804	1850	1897	1944	1990
	4 yds								

BA4SM

w95" d28.5" h33" sh17"

four seat unit, metal seat and back with upholstered pads shipping 225 lbs.

Perforated Metal	1534								
Seat + Back Pads	1994	1994	2052	2111	2169	2227	2286	2344	2402
	5 yds								

BA5SM

w118" d28.5" h33" sh17"

five seat unit, metal seat and back with upholstered pads shipping 280 lbs.

Perforated Metal	1483								
Seat + Back Pads	1856	1856	1903	1950	1996	2043	2090	2136	2183
	4 yds								

BA4SINSM

w105" d33" h33" sh17"

Inside curve four seat unit, metal seat and back with upholstered pads, inc. wedge table shipping 211 lbs.

Perforated Metal	1719								
Seat + Back Pads	2183	2183	2241	2300	2358	2416	2475	2533	2591
	5 yds								

BA5SOUTM

w119.5" d33" h33" sh17"

Outside curve five seat unit, metal seat and back with upholstered pads shipping 243 lbs.

Perforated Metal	3902								
Seat + Back Pads	4447	4447	4517	4587	4657	4727	4797	4867	4937
	6 yds								

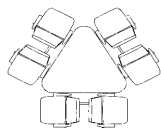

BACLUSTERM

w104" d92" h33" sh17"

six seat cluster unit, with laminate central table shipping 472 lbs.

Solid surface	1325								
Granite	1423								

BACLUSTERM

w104" d92" h33" sh17"

optional cluster table top (upcharge) shipping 200 lbs.

Seat + Back pad	939	939	973	1007	1041	1075	1109	1143	1177
	3 yards								

BA2SMBAR

w59.5" d28.5" h33" sh17"

two seat extra wide (26") unit (may require extra lead time) shipping 170 lbs.

Seat + Back pad	1260	1260	1305	1350	1396	1441	1486	1532	1577
	4 yards								

BA3SMBAR

w87.5" d28.5" h33" sh17"

three seat extra wide (26") unit (may require extra lead time) shipping 225 lbs.

Model No.	C.O.M.	A	B	C	D	E	F	G	H
-----------	--------	---	---	---	---	---	---	---	---

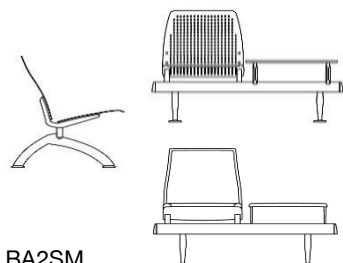

Unit price includes seats and a 21" table.

BA2SM w49" d28.5" h33" sh17"	Perforated Metal (No Upholstery)	615								
	Seat + Back Pads	885	885	897	908	920	932	944	955	967
		1 yd								
one seat unit, metal seat and back with pads and 21" laminate table										shipping 115 lbs.

	Perforated Metal	923								
	Seat + Back Pads	1220	1220	1244	1267	1290	1314	1337	1360	1384
		2 yds								

BA3SM w72" d28.5" h33" sh17"	two seat unit, metal seat and back with pads and 21" laminate table										shipping 170 lbs.
--	--	--	--	--	--	--	--	--	--	--	-------------------

	Perforated Metal	1198								
	Seat + Back Pads	1550	1550	1585	1620	1655	1690	1725	1760	1795
		3 yds								

BA4SM w95" d28.5" h33" sh17"	three seat unit, metal seat and back with pads and 21" laminate table										shipping 225 lbs.
--	--	--	--	--	--	--	--	--	--	--	-------------------

	Perforated Metal	1437								
	Seat + Back Pads	1916	1916	1962	2009	2056	2102	2149	2196	2243
		4 yds								

BA5SM w118" d28.5" h33" sh17"	four seat unit, metal seat and back with pads and 21" laminate table										shipping 280 lbs.
---	---	--	--	--	--	--	--	--	--	--	-------------------

	Perforated Metal	1386								
	Seat + Back Pads	1904	1904	1939	1974	2009	2044	2079	2114	2149
		3 yds								

BA4SINSM w105" d33" h33" sh17"	Inside curve three seats, inc. wedge table, plus 21" laminate table										shipping 225 lbs.
--	--	--	--	--	--	--	--	--	--	--	-------------------

	Perforated Metal	1623								
	Seat + Back Pads	2270	2270	2316	2363	2410	2457	2503	2550	2597
		4 yds								

BA5SOUTM w119.5" d33" h33" sh17"	Outside curve four seat unit, metal seat and back with pads, and 21" laminate table										shipping 290 lbs.
--	--	--	--	--	--	--	--	--	--	--	-------------------



BERNTABLE w24.5" d19" h"17"	Solid surface	365								
21" table (upcharge)										shipping 12 lbs.

shipping specifications Bernù aero metal is shipped for local assembly. Every 12 seats occupy an estimated 60 cu.ft. of shipping space. A minimum order will occupy an estimated 20 cu.ft. Please contact factory for specific shipping specifications. Weight is as shown above.

assembly Average assembly time is 45 minutes for 2 people to assemble a 4 seat unit.

construction	Foam	finish	Upholstered Pads	to order specify
Legs, Seat sides, Arms & End Caps	- Moulded CFC-free fire retardant HR urethane	Aluminum	- Standard Arconas grade-in fabrics.	- Model number
Beam	- Die cast aluminum	- Satin with bright polished accents	Metal Seat Pads	- Fabric
Seat and Back	- Anodized beam	Perforated Seatbacks	- Powder coat in cloud silver (standard finish)	- Table top finish
embroidery	- Perforated or solid steel panels	- Powder coat with Arconas standard colours	tables	- Layout
	legs	- Floor mounting cantilever leg option available	- Standard Arconas laminates with vinyl edge	
			- Standard Arconas solid surface	

Model No.	Upholstery Options	Wood	C.O.M.	A	B	C	D	E	F	G	H
-----------	--------------------	------	--------	---	---	---	---	---	---	---	---

Unit price includes seats only.

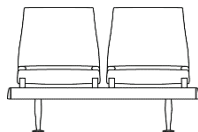

No upholstery	805										
Seat Pad Only	1 yd	929	929	941	953	964	976	988	999	1011	
Seat + Back Pad	2 yds	1002	1002	1026	1049	1073	1096	1119	1143	1166	
two seat unit, wood seat and back											shipping 90 lbs.

BA2SW

w49" d28.5" h33" sh17"

No upholstery	1055										
Seat Pad Only	1.5 yds	1241	1241	1258	1275	1293	1310	1328	1345	1363	
Seat + Back Pad	3 yds	1351	1351	1386	1421	1453	1491	1526	1561	1596	
three seat unit, wood seat and back											shipping 125 lbs.

BA3SW

w72" d28.5" h33" sh17"

No upholstery	1337										
Seat Pad Only	2 yds	1586	1586	1609	1633	1656	1679	1703	1726	1749	
Seat + Back Pad	4 yds	1732	1732	1779	1826	1872	1919	1965	2012	2059	
four seat unit, wood seat and back											shipping 170 lbs.

BA4SW

w95" d28.5" h33" sh17"

No upholstery	1587										
Seat Pad Only	2.5 yds	1899	1899	1928	1957	1986	2015	2045	2074	2103	
Seat + Back Pad	5 yds	2081	2081	2139	2198	2256	2315	2373	2431	2490	
five seat unit, wood seat and back											shipping 210 lbs.

BA5SW

w118" d28.5" h33" sh17"

No upholstery	1659										
Seat Pad Only	2 yds	1908	1908	1931	1954	1978	2001	2024	2048	2071	
Seat + Back Pad	4 yds	2054	2054	2101	2148	2194	2241	2288	2335	2381	
Inside curve four seat unit, wood seat and back, inc. laminate wedge table											shipping 170 lbs.

BA4SINSW

w105" d33" h33" sh17"

No upholstery	1769										
Seat Pad Only	2.5 yds	2081	2081	2110	2139	2169	2198	2227	2256	2285	
Seat + Back Pad	5 yds	2264	2264	2322	2381	2439	2497	2556	2614	2673	
Outside curve five seat unit, wood seat and back											shipping 210 lbs.

BA5SOUTW

w119.5" d33" h33" sh17"

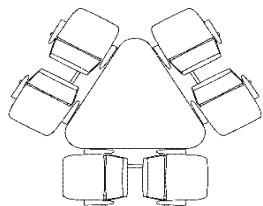

No upholstery	3925										
Seat Pad Only	3 yds	4308	4308	4343	4378	4413	4448	4483	4518	4554	
Seat + Back Pad	6 yds	4530	4530	4600	4670	4740	4810	4880	4950	5021	
six seat cluster unit, with laminate central table											shipping 350 lbs.

BACLUSTERW

w104" d92" h33" sh17"

Solid surface	1325										
Granite	1423										
optional cluster table top (upcharge)											shipping 200 lbs.

BACLUSTERW

w104" d92" h33" sh17"

Model No.	Upholstery Options	Wood	C.O.M.	A	B	C	D	E	F	G	H
-----------	--------------------	------	--------	---	---	---	---	---	---	---	---

Unit price includes seats and a 21" table.

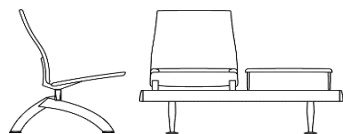

BA2SW

w49" d28.5" h33" sh17"

No upholstery	656										
Seat Pad Only	.5 yd	757	757	762	768	774	780	786	792	797	
Seat + Back Pad	1 yd	797	797	808	820	832	843	855	867	878	

one seat unit, wood seat and back and 21" laminate table shipping 90 lbs.

BA3SW

w72" d28.5" h33" sh17"

No upholstery	1058										
Seat Pad Only	1 yd	1182	1182	1194	1205	1217	1229	1241	1252	1264	
Seat + Back Pad	2 yds	1255	1255	1279	1302	1325	1349	1372	1395	1419	

two seat unit, wood seat and back and 21" laminate table shipping 125 lbs.

BA4SW

w95" d28.5" h33" sh17"

No upholstery	1307										
Seat Pad Only	1.5 yds	1494	1494	1511	1528	1546	1563	1581	1599	1616	
Seat + Back Pad	3 yds	1604	1604	1639	1674	1709	1744	1779	1814	1849	

three seat unit, wood seat and back and 21" laminate table shipping 170 lbs.

BA5SW

w118" d28.5" h33" sh17"

No upholstery	1590										
Seat Pad Only	2 yds	1839	1839	1862	1885	1909	1932	1956	1979	2002	
Seat + Back Pad	4 yds	1985	1985	2032	2079	2125	2172	2219	2265	2312	

four seat unit, wood seat and back and 21" laminate table shipping 210 lbs.

BA4SINSW

w105" d33" h33" sh17"

No upholstery	1661										
Seat Pad Only	1.5 yds	1847	1847	1864	1882	1900	1917	1935	1952	1970	
Seat + Back Pad	3 yds	1957	1957	1992	2027	2062	2097	2132	2167	2202	

Inside curve three seats inc. wedge table and 21" laminate table shipping 170 lbs.

BA5SOUTW

w119.5" d33" h33" sh17"

No upholstery	1944										
Seat Pad Only	2 yds	2193	2193	2216	2239	2262	2286	2309	2333	2356	
Seat + Back Pad	4 yds	2339	2339	2385	2432	2479	2525	2572	2619	2666	

Outside curve four seat unit, wood seat and back, and 21" laminate table shipping 210 lbs.



BERNTABLE

w24.5" d19" h"17"

Solid surface	365										
---------------	-----	--	--	--	--	--	--	--	--	--	--

21" table (upcharge) shipping 12 lbs.

shipping specifications

Bernù aero wood is shipped for local assembly. Every 12 seats occupy an estimated 60 cu.ft. of shipping space. A minimum order will occupy an estimated 20 cu.ft. Please contact factory for specific shipping specifications. Weight is as shown above.

assembly

Average assembly time is 45 minutes for 2 people to assemble a 4 seat unit.

construction

Legs, Arms & End Caps

- Die cast aluminum

Beam

- Anodized beam

Seat and Back

- Moulded Plywood

Foam

- CFC-free fire retardant
HR urethane

finish

Aluminum
- Satin with bright
polished accents

Seat and Back

- Maple
- Oak
- Walnut
- Custom wood options available
Minimum quantities apply.

tables

- Standard Arconas
laminates w/ vinyl edge
or solid surface

legs

- Floor mounting cantilever
leg option available

to order specify

- Model number
- Fabric
- Table top finish
- Layout

Model No. Price

Unit price includes seats only.

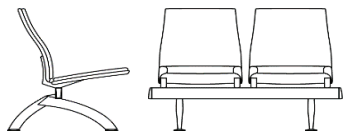

968

BP2SP

w49" d28.5" h33" sh17"

two seat unit, polyurethane seat and back

shipping 115 lbs.

1297

BP3SP

w72" d28.5" h33" sh17"

three seat unit, polyurethane seat and back

shipping 170 lbs.

1664

BP4SP

w95" d28.5" h33" sh17"

four seat unit, polyurethane seat and back

shipping 225 lbs.

1994

BP5SP

w118" d28.5" h33" sh17"

five seat unit, polyurethane seat and back

shipping 280 lbs.

1856

BP4SINSP

w105" d32.5" h33" sh17"

Inside curve four seat unit, polyurethane seat and back, inc. wedge table

shipping 190 lbs.

2183

BP5SOUTP

w119.5" d33" h33" sh17"

Outside curve five seat unit, polyurethane seat and back

shipping 218 lbs.

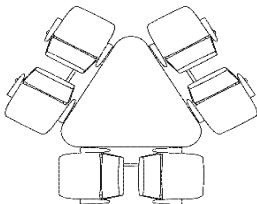

4447

BPCLUSTER

w104" d92" h33" sh17"

six seat cluster unit, with laminate central table

shipping 350 lbs.

Solid surface 1325

Granite 1423

BPCLUSTER

w104" d92" h33" sh17"

optional cluster table top (upcharge)

shipping 200 lbs.

Model No. Price

Unit price includes seats and a 21" table.

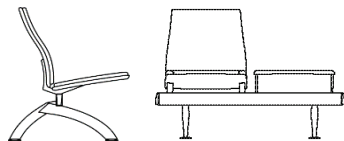

885

BP2SP

w49" d28.5" h33" sh17"

one seat unit, polyurethane seat and back and 21" laminate table

shipping 95 lbs.

1220

BP3SP

w72" d28.5" h33" sh17"

two seat unit, polyurethane seat and back and 21" laminate table

shipping 127 lbs.

1550

BP4SP

w95" d28.5" h33" sh17"

three seat unit, polyurethane seat and back and 21" laminate table

shipping 175 lbs.

1916

BP5SP

w118" d28.5" h33" sh17"

four seat unit, polyurethane seat and back and 21" laminate table

shipping 200 lbs.

1904

BP4SINSP

w105" d32.5" h33" sh17"

Inside curve three seat unit, polyurethane seat and back, inc. wedge table and 21" laminate table

shipping 225 lbs.

2270

BP5SOUTP

w119.5" d33" h33" sh17"

Outside curve four seat unit, polyurethane seat and back and 21" laminate table

shipping 290 lbs.



Solid surface 365

BERNTABLE

w24.5" d19" h"17

21" table (upcharge)

shipping 12 lbs.

shipping specifications

Bernù aero poly is shipped for local assembly. Every 12 seats occupy an estimated 60 cu.ft. of shipping space. A minimum order will occupy an estimated 20 cu.ft. Please contact factory for specific shipping specifications. Weight is as shown above.

assembly

Average assembly time is 45 minutes for 2 people to assemble a 4 seat unit.

construction

Legs, Arms & End Caps

- Die cast aluminum

Seat and Back

- Contoured self-skinning polyurethane foam moulded over steel frame

Beam

- Anodized beam

power

- Power options available

See page 69

finish

Aluminum

- Satin with bright polished accents

Seat and Back

- Three standard colours

legs

- Floor mounting cantilever option available

tables

- Standard Arconas laminates w/ vinyl edge

- Standard Arconas

solid surface

to order specify

- Model number

- Fabric

- Table top finish

- Layout

Model No. Price

Unit price includes seats only.

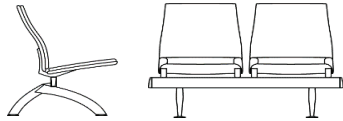

BP2SWP

w49" d28.5" h33" sh17"

886

two seat unit, polyurethane seat and wood back

shipping 76 lbs.

1176

BP3SWP

w72" d28.5" h33" sh17"

three seat unit, polyurethane seat and wood back

shipping 100 lbs.

1500

BP4SWP

w95" d28.5" h33" sh17"

four seat unit, polyurethane seat and wood back

shipping 140 lbs.

1790

BP5SWP

w118" d28.5" h33" sh17"

five seat unit, polyurethane seat and wood back

shipping 165 lbs.

1758

BP4INSWP

w105" d32.5" h33" sh17"

Inside curve four seat unit, polyurethane seat and wood back, inc. wedge table

shipping 155 lbs.

1976

BP5OUTSWP

w119.5" d33" h33" sh17"

Outside curve five seat unit, polyurethane seat and wood back

shipping 175 lbs.

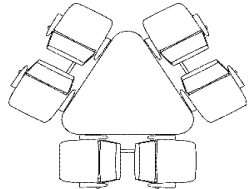

4245

BACLUSTERWP

w104" d92" h33" sh17"

six seat cluster unit, with laminate central table

shipping 390 lbs.

Solid surface 1325

Granite 1423

BACLUSTERWP

w104" d92" h33" sh17"

optional cluster table top (upcharge)

shipping 200 lbs.

Model No. Price

Unit price includes seats and a 21" table.

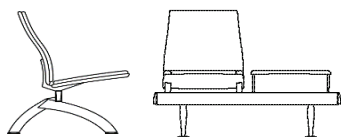

770

BP2SWP

w49" d28.5" h33" sh17"

one seat unit, polyurethane seat and wood back and 21" laminate table

shipping 105 lbs.

1139

BP3SWP

w72" d28.5" h33" sh17"

two seat unit, polyurethane seat and wood back and 21" laminate table

shipping 150 lbs.

1550

BP4SWP

w95" d28.5" h33" sh17"

three seat unit, polyurethane seat and wood back and 21" laminate table

shipping 200 lbs.

1753

BP5SWP

w118" d28.5" h33" sh17"

four seat unit, polyurethane seat and wood back and 21" laminate table

shipping 250 lbs.

1782

BP4INSWP

w105" d32.5" h33" sh17"

Inside curve three seat unit, polyurethane seat and wood back, inc. wedge table and 21" laminate table

shipping 215 lbs.

2106

BP5OUTSWP

w119.5" d33" h33" sh17"

Outside curve four seat unit, polyurethane seat and wood back and 21" laminate table

shipping 250 lbs.



Solid surface

365

BERNTABLE

w24.5" d19" h17"

21" table (upcharge)

shipping 15 lbs.

shipping specifications

Bernù aero wood/poly is shipped for local assembly. Every 12 seats occupy an estimated 60 cu.ft. of shipping space. A minimum order will occupy an estimated 20 cu.ft. Please contact factory for specific shipping specifications. Weight is as shown above.

assembly

Average assembly time is 45 minutes for 2 people to assemble a 4 seat unit.

construction

Legs, Arms & End Caps

- Die cast aluminum

Beam

- Anodized beam

Back - Moulded Plywood, Veneer

Seat - Ergonomically contoured self-skinning polyurethane foam moulded over steel frame,

legs

- Cantilever options available

finish

Aluminum

- Satin with bright polished accents
- Custom wood options available.
- Minimum quantities apply.

Seat and Back

Seat - Standard Arconas poly colors
Back - wood finishes
- Maple
- Oak
- Walnut

- Combine any standard poly colour with any standard wood finish.

tables

- Standard Arconas laminates w/ vinyl edge
- Standard Arconas solid surface

to order specify

- Model number
- Seat finish
- Backrest finish
- Table top finish
- Layout

Model No. Solid Wood



1089

BB2SM/O/W

w48" d24" sh17"

two seat wood bench (Maple/Oak/Walnut)

shipping 70 lbs. 5 cu.ft. (Maple 55 lbs)



1386

BB3SM/O/W

w72" d24" sh17"

three seat wood bench (Maple/Oak/Walnut)

shipping 100 lbs. 7.5 cu.ft.

C.O.M.	A	B	C	D	E	F	G	H
--------	---	---	---	---	---	---	---	---



1110	1110	1128	1146	1163	1181	1198	1216	1233
------	------	------	------	------	------	------	------	------

1.5 yds

BB2SU

w48" d24" sh17"

two seat upholstered bench

shipping 130 lbs. 10 cu.ft.



1414	1414	1440	1467	1493	1519	1546	1571	1598
------	------	------	------	------	------	------	------	------

2.25 yds

BB3SU

w72" d24" sh17"

three seat upholstered bench

shipping 160 lbs. 12.5 cu.ft.

shipping specifications

Bernù bench is shipped for local assembly. Each bench occupies an estimated 5 cu.ft. of shipping space.

A minimum order will occupy an estimated 1 cu.ft. Please contact factory for specific shipping specifications. Weight is as shown above.

assembly

Average assembly time is 10 minutes for 2 people to assemble a bench unit.

construction

- Legs & End Caps**
 - Die cast aluminum
- Beam**
 - Anodized beam



- Wood Seat**
 - Hard wood slats
- Upholstered seat pad**
 - CFC-free fire retardant
 HR urethane foam







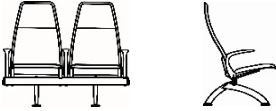

finish

- Aluminum**
 - Satin with bright polished accents
- Seat - solid wood**
 - Maple
 - Oak
 - Walnut
 - Custom wood options available
 Minimum quantities apply.

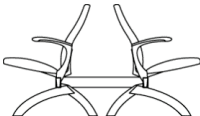
to order specify

- Product name
- Model number
- Fabric / Wood Finish
- Layout

Model No.	C.O.M.	A	B	C	D	E	F	G	H	
 <p>BALUXE2SM w49" d28.5" h44.5" sh17"</p>	1284 3 yds	1284	1318	1352	1386	1420	1454	1488	1522	
		two seat bernu luxe unit with upholstered pads							shipping 200 lbs.	
<p>BALUXE3SM w72" d28.5" h44.5" sh17"</p>	1772 4.5 yds	1772	1823	1874	1925	1976	2027	2078	2129	
		three seat bernu luxe unit with upholstered pads							shipping 300 lbs.	
<p>BALUXE4SM w95" d28.5" h44.5" sh17"</p>	2296 6 yds	2296	2364	2432	2501	2569	2637	2705	2773	
		four seat bernu luxe unit with upholstered pads							shipping 400 lbs.	
<p>BALUXE5SM w118" d28.5" h44.5" sh17"</p>	2785 7.5 yds	2785	2870	2955	3040	3125	3210	3295	3380	
		five seat bernu luxe unit with upholstered pads							shipping 500 lbs	
 <p>BERNCHAISE w21.5" d28.5" h44.5" sh17"</p>	158 1.5 yds	158	175	192	209	226	243	260	277	
		bernù luxe upholstered footrest							shipping 40lbs	

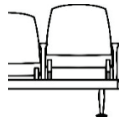
Model No.	Price		
	76		
BERNARM w2" d14.5" ah12"	solid-die cast aluminum loop arm		shipping 6 lbs.
	42		
BERNALARM w2" d14.5" ah12"	solid die-cast aluminum cantilever arm		shipping 4 lbs.
	70		
BERNALDRINK dia3.5" d5" ah22.5"	solid die-cast aluminum drink holder arm		shipping 5 lbs.
	set of two 144		
BERNBTOBR w28.5" d4" h3.5"	bernù aero retrofit back to back connector		shipping 16 lbs.
	83		
IP2580 w9.45" d2.75" h4"	bernu aero retrofit back to back connector ADA bracket		shipping 2 lb.
	solid surface 152		
68032 w9" d20" h17"	9" wedge table, for curved units (upcharge)		shipping 5 lbs.
	43		
GLIDE-FLOOR dia3"	floor mounting glides, set of 2 (upcharge)		shipping 1 lb.
	set of four 79 set of six 119		
GLIDE-NONSLIP dia3"	antislid glide for hard floors (upcharge)		shipping 1 lb.
	32		
IP2545 w20.5" d2.75" h2.75"	cable management device for power modules (linear units only)		shipping 2 lbs
	set of two 65		
68173 d28.5" h36" sh20"	prm (persons with reduced mobility) raised seat bracket. For 4-5 seat units only. 1 seat per unit.		shipping 110lbs

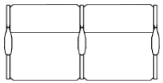

two seat unit



Accessibility embroidery options

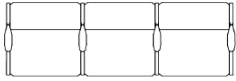

three seat unit

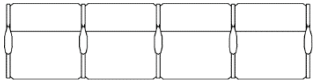

four seat unit

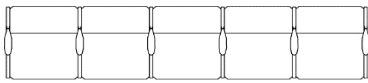

five seat unit



single units

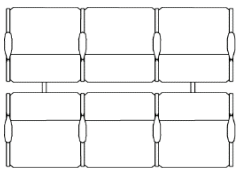

two to five seat unit

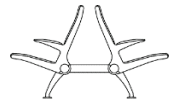

back to back units



two seat unit

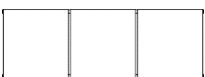

three seat unit



four seat unit

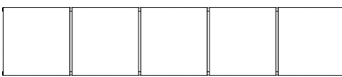

five seat unit



bench units



end table



corner table



intermediate table



connecting table

tables

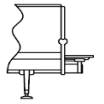
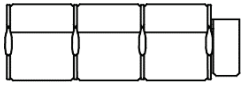

end table

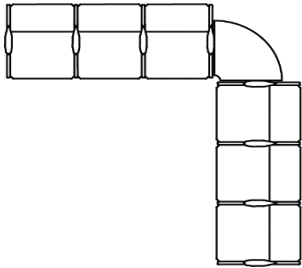

corner table, connects seat units at 90 degrees

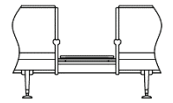
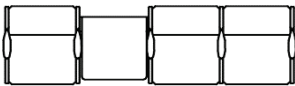

intermediate table, replaces an interior seat position

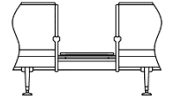
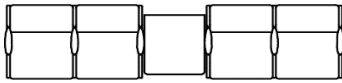

connecting table, connects seat units

units with tables

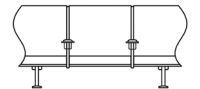
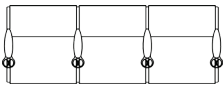

drink holders

units with drink holders

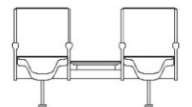
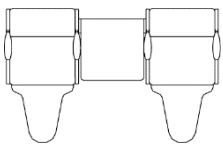

footrests with intermediate table

units with footrests

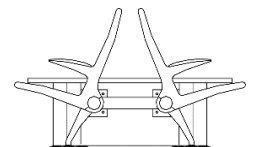
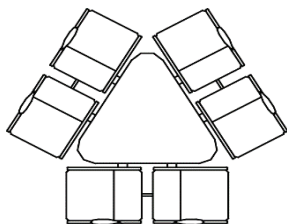

cluster unit, with central table

cluster unit

flyaway cluster layout options

designer douglas ball

public and modular

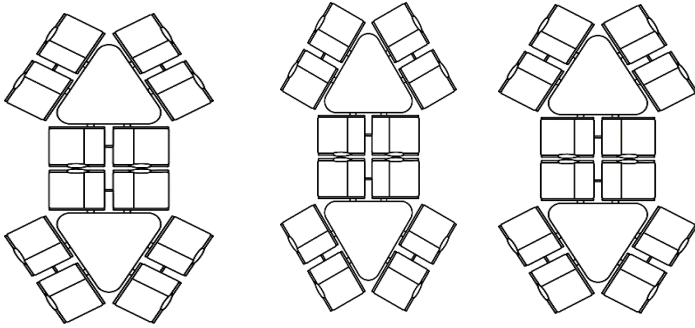

duo

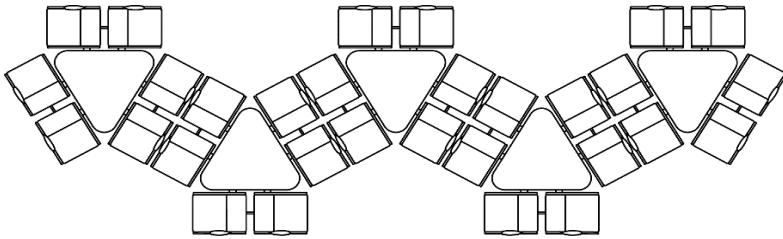

link

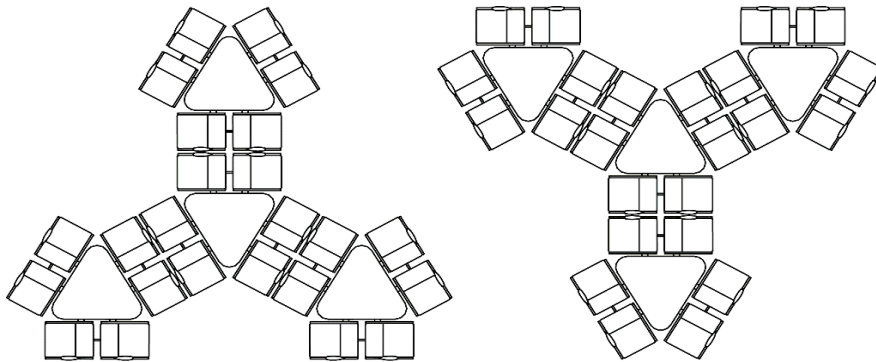

alliance

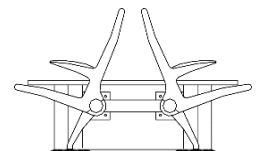
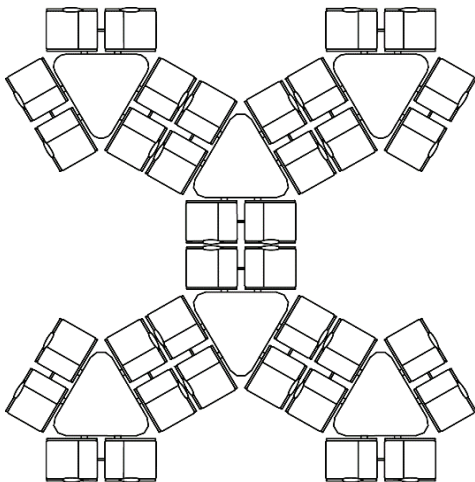

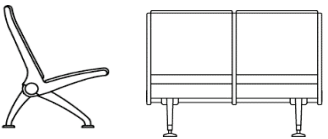

family

cluster layouts

Model No.	C.O.M.	A	B	C	D	E	F	G	H
	1421	1421	1449	1477	1506	1534	1562	1591	1619
	2.5 yds								
FLY2S	two seat unit (no arms)								shipping 117 lbs.
w46.5" d29.5" h36.5" sh17.5"									

	1951	1951	1991	2030	2070	2110	2150	2189	2229
	3.75 yds								
FLY3S	three seat unit (no arms)								shipping 165 lbs.
w69" d29.5" h36.5" sh17.5"									

	2481	2481	2535	2588	2642	2696	2750	2804	2857
	5 yds								
FLY4S	four seat unit (no arms)								shipping 205 lbs.
w92" d29.5" h36.5" sh17.5"									

	3037	3037	3103	3168	3233	3298	3363	3430	3493
	6.25 yds								
FLY5S	five seat unit (no arms)								shipping 250 lbs.
w115" d29.5" h36.5" sh17.5"									

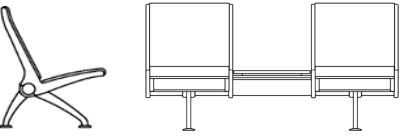
	2061	2061	2101	2140	2180	2219	2259	2299	2339
	2.5yds								
FLY3S	two seat unit (no arms), and intermediate laminate table								shipping 165 lbs.
w69" d29.5" h36.5" sh17.5"									

	2590	2590	2644	2698	2752	2806	2860	2914	2967
	3.75 yds								
FLY4S	three seat unit (no arms), and intermediate laminate table								shipping 205 lbs.
w92" d29.5" h36.5" sh17.5"									

	3147	3147	3212	3278	3342	3408	3473	3538	3603
	5yds								
FLY5S	four seat unit (no arms), and intermediate laminate table								shipping 250 lbs.
w115" d29.5" h36.5" sh17.5"									

shipping specifications Flyaway is shipped for local assembly. Every 10 seats occupy an estimated 50 cu.ft. of shipping space. A minimum order will occupy an estimated 20 cu.ft. Please contact factory for specific shipping specifications. Weight is as shown above.

assembly Average assembly time is 1.5 hours for 2 people to assemble a 4 seat unit.

construction	finish	to order specify
Legs, Seat sides and Arms - Die cast aluminum	Aluminum - Satin - Bright polish	- Product name - Model number - Aluminum finish
Seat and Back - Steel pan molded into CFC-free fire retardant HR urethane	Frame and Back - Powder coated - Cloud silver	- Fabric - Top finish as appropriate - Layout
Frame - 3.5" diameter steel tube	embroidery Accessibility logos - Call for pricing. Minimum quantities apply.	
Back to Back Connection - 1"x 3" rectangular steel tube		
End Caps - Nylon		

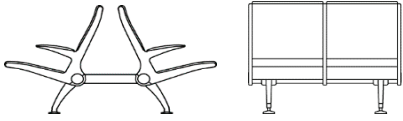
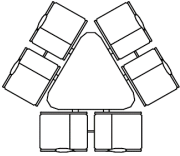
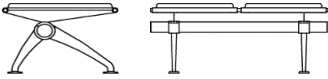
Model No.	C.O.M.	A	B	C	D	E	F	G	H		
 <p>FLY4D w46.5" d61.5" h36.5" sh17.5"</p>	2891	2891	2945	2999	3052	3106	3160	3214	3268		
	5 yds	four seat unit back to back, (two seats per side, no arms)								shipping 265 lbs.	
<p>FLY6D w69" d61.5" h36.5" sh17.5"</p>	3951	3951	4030	4110	4189	4268	4348	4427	4506		
	7.5 yds	six seat unit back to back, (three seats per side, no arms)								shipping 325 lbs.	
<p>FLY8D w92" d61.5" h36.5" sh17.5"</p>	5011	5011	5115	5220	5325	5430	5535	5640	5745		
	10 yds	eight seat unit back to back, (four seats per side, no arms)								shipping 420 lbs.	
<p>FLY10D w115" d61.5" h36.5" sh17.5"</p>	6124	6124	6254	6384	6515	6645	6776	6906	7036		
	12.5 yds	ten seat unit back to back, (five seats per side, no arms)								shipping 515 lbs.	
 <p>FLYCLUSTER w107.5" d94" h36.5" sh17.5"</p>	4688	4688	4768	4847	4926	5006	5085	5164	5244		
	7.5 yds	six seat cluster unit, with laminate central table								shipping 500 lbs.	
	Solid surface	1288									
<p>FLYCLUSTER w104" d92" h33" sh17"</p>	optional cluster table tops (upcharge)								shipping 200 lbs.		
	Perforated Powder Perforated Coated Stainless										
Benches (Indoor only)	Steel	Steel	C.O.M.	A	B	C	D	E	F	G	H
 <p>FLY2B w45" d26" h18"</p>	1060	1255	1105	1105	1117	1128	1139	1151	1162	1173	1185
	1 yd	two seat bench								shipping 77 lbs. 5 cu.ft.	
<p>FLY3B w68" d26" h18"</p>	1511	1807.3	1579	1579	1596	1613	1630	1647	1664	1681	1698
	1.5 yds	three seat bench								shipping 90 lbs. 7.5 cu.ft.	
<p>FLY4B w91" d26" h18"</p>	1994	2389.9	2085	2085	2107	2130	2153	2175	2198	2221	2243
	2 yds	four seat bench								shipping 115 lbs. 10 cu.ft.	
<p>FLY5B w114" d26" h18"</p>	2417	2927.6	2530	2530	2559	2587	2616	2644	2672	2700	2729
	2.5 yds	five seat bench								shipping 140 lbs. 12.5 cu.ft.	

Model No.		Price		
		Laminate	339	shipping 40 lbs.
		Solid Surface	657	shipping 48 lbs.
		Granite	702	shipping 55 lbs.

FLYENDTAB

w9" d23" h17.5"

end table (includes beam extension and table brackets)

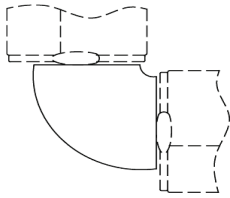

Laminate	375	shipping 50 lbs.
Solid Surface	738	shipping 48 lbs.
Granite	783	shipping 65 lbs.

FLYCORNTAB-IN/OUT

w30.5" d30.75" h17.5"

inside and outside corner table (connects two units at 90 degrees)

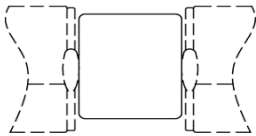

Laminate	110	shipping 40 lbs.
Solid Surface	458	shipping 48 lbs.
Granite	503	shipping 55 lbs.

FLYINTTAB

w21" d23" h17.5"

intermediate table (replaces an interior seat position)

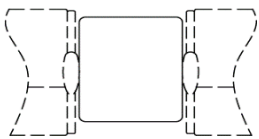







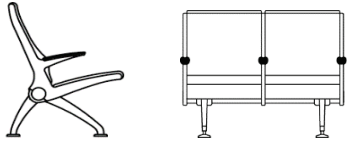

Laminate	263	shipping 40 lbs.
Solid Surface	607	shipping 48 lbs.
Granite	652	shipping 55 lbs.

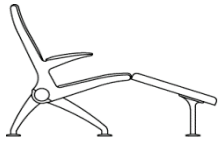
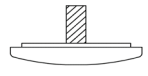
FLYCONNTAB

w21" d23" sh17.5"

connecting table (connects two units in a row)

Model No.	Price																											
 <p>FLYARM w2.75" d11" ah22.5"</p>	<p><u>arm with black molded arm pad</u> 34</p> <p><u>all aluminum arm</u> 34</p> <p>arm, black molded arm pad on casting or all aluminum shipping 9 lbs.</p>																											
 <p>FLYDRINK dia3.5" d5" ah22.5"</p>	<p>63</p> <p>drink holder, polished stainless steel. Only for arm with black molded arm pad shipping 4 lbs.</p>																											
 <p>FLY-FR w22" d22" h17"</p>	<table border="1"> <thead> <tr> <th>C.O.M.</th> <th>A</th> <th>B</th> <th>C</th> <th>D</th> <th>E</th> <th>F</th> <th>G</th> <th>H</th> </tr> </thead> <tbody> <tr> <td>238.04</td> <td>238.04</td> <td>249.37</td> <td>260.71</td> <td>272.04</td> <td>283.38</td> <td>294.71</td> <td>306.05</td> <td>317.38</td> </tr> <tr> <td>1 yd</td> <td></td> <td></td> <td></td> <td></td> <td></td> <td></td> <td></td> <td></td> </tr> </tbody> </table> <p>footrest shipping 15 lbs.</p>	C.O.M.	A	B	C	D	E	F	G	H	238.04	238.04	249.37	260.71	272.04	283.38	294.71	306.05	317.38	1 yd								
C.O.M.	A	B	C	D	E	F	G	H																				
238.04	238.04	249.37	260.71	272.04	283.38	294.71	306.05	317.38																				
1 yd																												
 <p>GLIDE-FLOOR dia3"</p>	<p>43</p> <p>floor mounting glides, set of 2 (upcharge) shipping .5 lbs.</p>																											
 <p>GLIDE-NONSLIP dia3"</p>	<p>set of four 79</p> <p>antislip glide for hard floors, set of 4 (upcharge) shipping .5 lbs.</p>																											

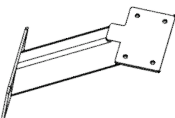
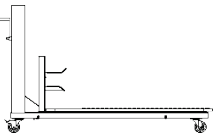
Model No.	Price		
	71	standard flyaway cable management device for 2 & 3 seat units	shipping 1.5 lbs.
IP2510 w20" d4" h2.5"			
	142	flyaway cable management device for 4 seat units	shipping 2.3 lbs.
IP2576 w42.5" d4" h2.5"			
	213	flyaway cable management device for 5 seat units	shipping 3.5 lbs.
IP2575 w65.5" d4" h2.5"			
	set of two 449	flyaway retrofittable back to back connector	shipping 20lbs.
FLYBTOBR w25.75" d3" h5.5"			
	177	flyaway retrofittable back to back connector ADA bracket	shipping 5lbs.
FLYBTOBRADA w9.45" d2.75" h4"			
	5443	furniture mover	shipping 210 lbs.
FLYMOVER w28" d66.5" h44"			

standard configuration (wider gap between seats with power and arm options.)

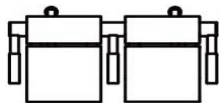

two seat unit



Accessibility embroidery options

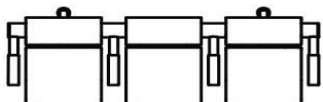

three seat unit

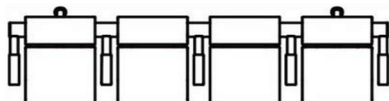

four seat unit

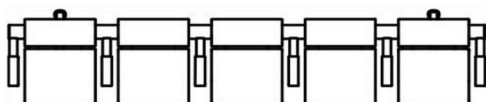

five seat unit



single units with arm options

tandem configuration (narrow gap between seats, with arms only. Power option not available.)

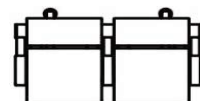

two seat unit

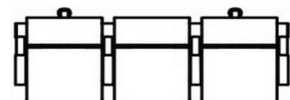

three seat unit

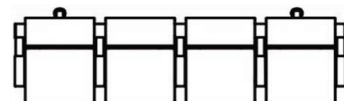

four seat unit

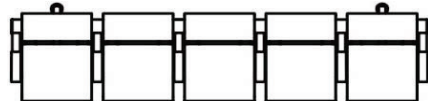

five seat unit



single units with arms

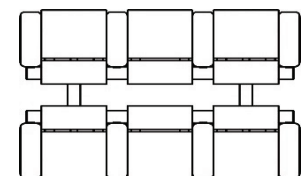

two to five seat unit

back to back units



table, can be located at any seat position

table

standard configuration shown with power and drink holder arms

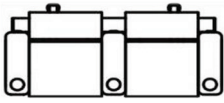

two seat unit

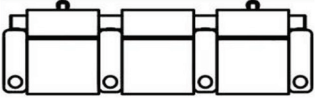

three seat unit

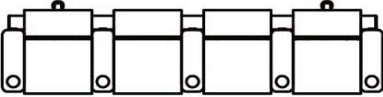

four seat unit

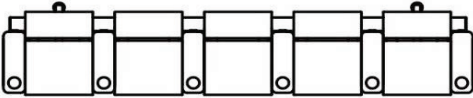

five seat unit

single units with tablet arms, power & drink holders

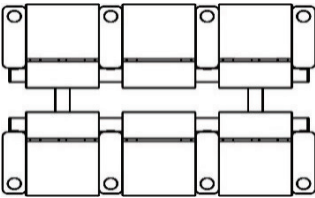

two to five seat unit

back to back units

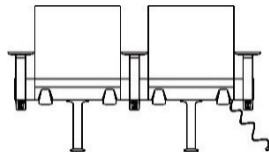
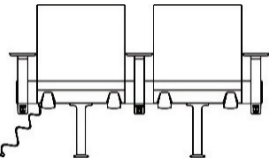

inlet located left or right (when facing)

power cord management

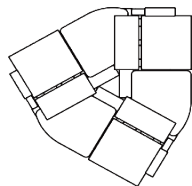

three seat cluster unit

standard configuration (wide gap between seats - available with power and arm options.)

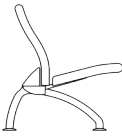
Model No.	C.O.M.	A	B	C	D	E	F	G	H
 PLA2SS w56" d28" h36" sh17.5"	1069	1069	1104	1139	1174	1209	1244	1279	1314
	3 yds	two seat unit							shipping 100 lbs.
PLA3SS w82" d28" h36" sh17.5"	1571	1571	1624	1677	1729	1782	1834	1887	1939
	4.5 yds	three seat unit							shipping 140 lbs.
PLA4SS w109" d28" h36" sh17.5"	2073	2073	2144	2214	2284	2354	2424	2494	2564
	6 yds	four seat unit							shipping 220 lbs.
PLA5SS w136" d28" h36" sh17.5"	2565	2565	2653	2740	2828	2915	3003	3091	3178
	7.5 yds	five seat unit							shipping 280 lbs.

tandem configuration (narrow gap between seats with cantilever arm option only - power not available.)

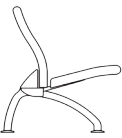
Model No.	C.O.M.	A	B	C	D	E	F	G	H
 PLA2ST w49" d28" h36" sh17.5"	1063	1063	1098	1134	1168	1203	1239	1274	1309
	3 yds	two seat unit							shipping 100 lbs.
PLA3ST w72" d28" h36" sh17.5"	1566	1566	1619	1671	1724	1776	1829	1882	1934
	4.5 yds	three seat unit							shipping 140 lbs.
PLA4ST w96" d28" h36" sh17.5"	2068	2068	2138	2209	2279	2349	2418	2489	2559
	6 yds	four seat unit							shipping 220 lbs.
PLA5ST w119" d28" h36" sh17.5"	2560	2560	2648	2735	2823	2910	2998	3085	3173
	7.5 yds	five seat unit							shipping 280 lbs.

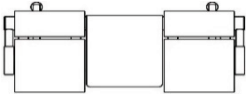
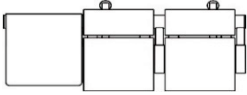
  PLATABLE	<u>Laminate</u>		<u>Solid Surface</u>		<u>Granite</u>				
	246		545		556				
table can replace any seat position									

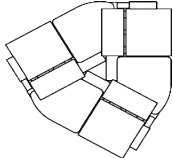
Model No.	C.O.M.	A	B	C	D	E	F	G	H
	2732	2732	2783	2834	2885	2936	2987	3038	3089
	4.5 yds								

PLACLUSTER

w64.25" d66.25" h36" sh17.5"

three seat cluster unit, with laminate central table

shipping 350 lbs.

- Phenolic 403
- Solid Surface 671

PLACLUSTER

w64.25" d66.25" h36" sh17.5"

optional cluster table tops (upcharge)

shipping 50 lbs.

476

PLAWIRE

standard fee

wiring inspection and certification fee

shipping specifications

Place is shipped for local assembly. Every 10 seats occupy an estimated 50 cu.ft. of shipping space. A minimum order will occupy an estimated 20 cu.ft. Please contact factory for specific shipping specifications. Weight is as shown above.

assembly

Average assembly time is 1 hour for 2 people to assemble a 4 seat unit.

construction

Legs and Arms

- Die cast aluminum

Beam

- Extruded aluminum

Seat and Back

- Steel pan molded into CFC-free fire retardant HR urethane

Power Module

- AC outlet & 2 USB ports
- Qi wireless unit must be ordered with PLAPOW

Tablet Arm

- Black phenolic surface

Pad Arm

- Black molded arm pad

Back to Back Connection

- Extruded aluminum

End Caps

- Nylon

finish

Aluminum

- Bright polish

tables

- Standard Arconas laminates with vinyl edge
- Standard Arconas solid surface/granite









embroidery

Accessibility logos

- Call for pricing. Minimum quantities apply.

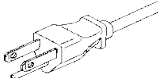
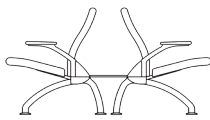
to order specify

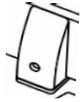
- Product name
- Model number
- Fabric
- Top finish as appropriate
- Layout

Model No.	Price		
	52		
PLACARM w2.75" d11" ah24"	black molded pad arm on casting		shipping .6 lbs.
	139	Fenix phenolic upcharge 30	
PLATARM w6" d11" ah24"	black phenolic tablet arm on casting (qi wireless must be purchased with PLAPOW)		shipping 10 lbs.
	165	Fenix phenolic upcharge 30	
PLATARMDH w6" dia3.5" d5" ah24"	black phenolic tablet arm with integrated drink holder on casting		shipping 11 lbs.
	182		
PLAPOW w2.5" d2.5" h2.5"	power module (AC connection + 2 USB ports; universal sockets available)		shipping .5 lbs.
	476		
PLAWIRE standard fee	wiring inspection and certification fee (per beam)		
	<u>IP2511</u> 12	<u>IP2512</u> 17	
<i>alternate length cords</i>	8- or 10-foot power cord	12- or 15-foot power cord	
	188		
PLABTOB adds 7.5" width to two single rows	back to back connector (set of two)		shipping 25 lbs.
	43		
GLIDE-FLOOR dia3"	floor mounting glides, set of 2 (upcharge)		shipping .5 lbs.
	79		
GLIDE-NONSLIP dia3"	antislid glide for hard floors, set of 4 (upcharge)		shipping .5 lbs.
	28		
PLAARMCOV	place arm cover		shipping .5 lbs.
	32		
PLAPOWCOV	place power cover		shipping .5 lbs.



single seat unit (W 24"/609 mm)



bariatric seat unit (W 30"/762 mm)



Accessibility embroidery options

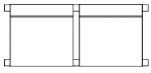

two seat unit

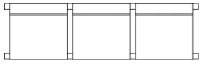

three seat unit

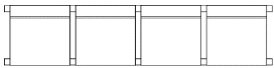

four seat unit

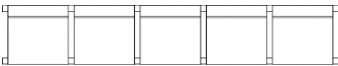

five seat unit



single units

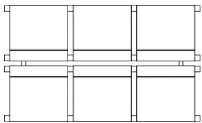

two to four seat unit

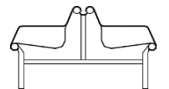

back to back units

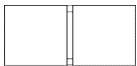

two seat unit



three seat unit

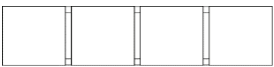

four seat unit

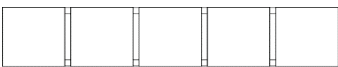

five seat unit



bench units



end table



tables

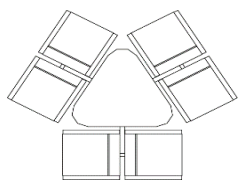

six seat cluster unit, with central table

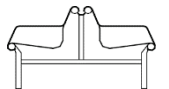

cluster unit

setz™ cluster layout options

designer arconas

public and modular

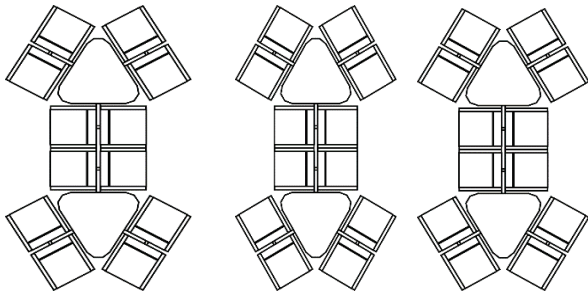

duo

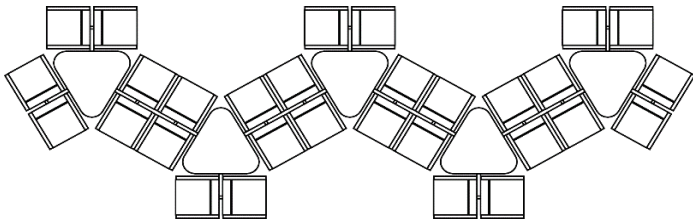

link

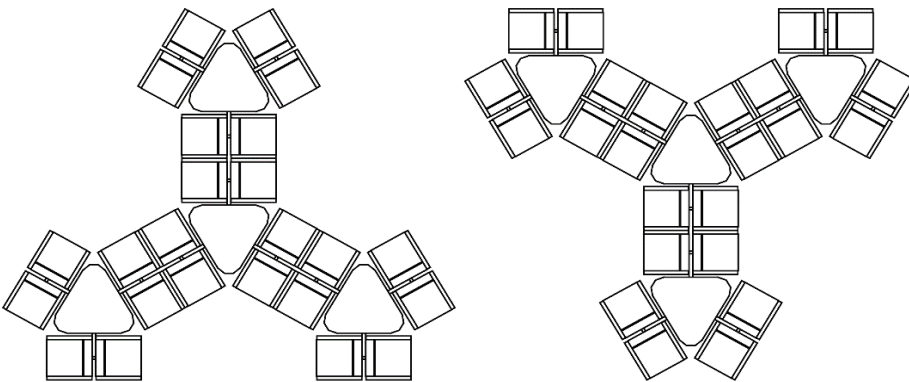

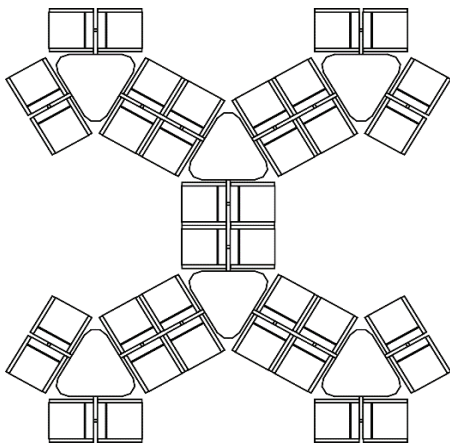

tripod

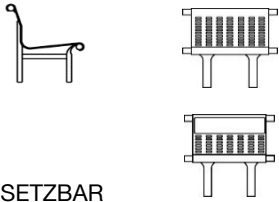
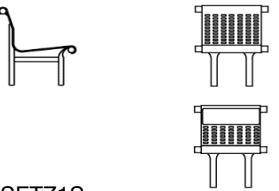
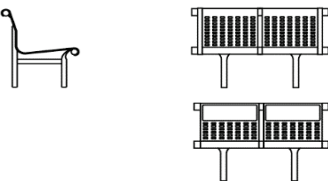

family

cluster layouts

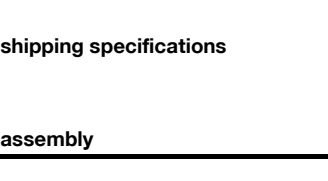
Model No.	Upholstery Options	Metal	C.O.M.	A	B	C	D	E	F	G	H
 SETZBAR w30" d23.5" h30.5" sh17.5"	No Upholstery	460									
	Seat + Back Pad	1 yd	631	631	643	655	666	678	690	702	714
single bariatric seat unit											shipping 75 lbs.
 SETZ1S w25" d23.5" h30.5" sh17.5"	No Upholstery	336									
	Seat + Back Pad	1 yd	443	443	455	467	478	490	502	514	525
single seat unit											shipping 70 lbs.
 SETZ2S w48" d23.5" h30.5" sh17.5"	No Upholstery	511									
	Seat + Back Pad	2 yds	699	699	722	746	769	793	817	840	864
two seat unit											shipping 90 lbs.
 SETZ3S w71" d23.5" h30.5" sh17.5"	No Upholstery	645									
	Seat + Back Pad	3 yds	908	908	943	978	1014	1049	1085	1120	1155
three seat unit											shipping 120 lbs.
 SETZ4S w94" d23.5" h30.5" sh17.5"	No Upholstery	780									
	Seat + Back Pad	4 yds	1117	1117	1164	1211	1258	1305	1352	1400	1447
four seat unit											shipping 150 lbs.
 SETZ5S w117" d23.5" h30.5" sh17.5"	No Upholstery	909									
	Seat + Back Pad	5 yds	1320	1320	1379	1438	1497	1556	1615	1674	1732
five seat unit											shipping 180 lbs.

shipping specifications

Setz is shipped for local assembly. Every 50 seats occupy an estimated 400 cu.ft. of shipping space. A minimum order will occupy an estimated 20 cu.ft. Please contact factory for specific shipping specifications. Weight is as shown above.

assembly

Average assembly time is 1 hour for 2 people to assemble a 4 seat unit.

construction

- Seats**
- Perforated steel
 - Tamper resistant hardware
- Supports**
- Tubular steel
- End Caps and Glides**
- Nylon
 - Sealed steel end caps

finish

- Powder coat
- See Arconas Standards for colour
- Zinc plated undercoat for outdoor use - add 13%
- Clear top coat recommended over metallic finishes, and outdoor use add \$67/seat

glide

- Units may be fixed to floor add \$92 per unit

tables

- Perforated steel

options

- Embroidery of company logo, accessibility symbol, etc. Call for pricing. Minimum quantities apply.
- Special safety features - add 10%
- Bariatric seat height 19.5". Call for pricing.

Model No.	Upholstery Options	Metal	C.O.M.	A	B	C	D	E	F	G	H
-----------	--------------------	-------	--------	---	---	---	---	---	---	---	---

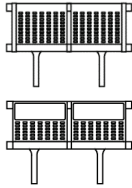
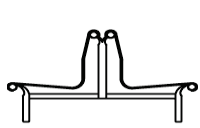

No Upholstery	940										
Seat + Back Pad	4 yds	1265	1265	1313	1360	1407	1454	1501	1548	1596	
SETZ4D											
w48" d49" h30.5" sh17.5"											
four seat unit back to back, (two seats per side)											
shipping 150 lbs.											

No Upholstery	1213										
Seat + Back Pad	6 yds	1677	1677	1747	1818	1889	1960	2030	2101	2172	

SETZ6D										
w71" d49" h30.5" sh17.5"										
six seat unit back to back, (three seats per side)										
shipping 210 lbs.										

No Upholstery	1492										
Seat + Back Pad	8 yds	2094	2094	2189	2283	2377	2471	2566	2660	2754	

SETZ8D										
w94" d49" h30.5" sh17.5"										
eight seat unit back to back, (four seats per side)										
shipping 270 lbs.										

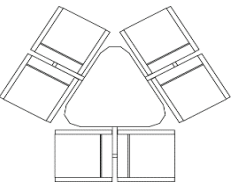

No Upholstery	2887										
Seat + Back Pad	6 yds	3342	3342	3413	3484	3555	3625	3696	3767	3837	
SETZ CLUSTER											
w96" d83.5" h30.5" sh17.5"											
six seat cluster unit, with laminate central table											
shipping 350 lbs.											

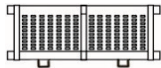
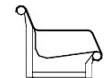

No Upholstery	460										
Seat + Back Pad	4 yds	629	629	652	676	700	723	747	770	794	
SETZ2WM											
w48" d23.5" h30.5" sh17.5"											
two seat wall mount unit											
shipping 90 lbs.											

No Upholstery	580										
Seat + Back Pad	3 yds	817	817	852	888	923	958	994	1029	1065	
SETZ3WM											
w71" d23.5" h30.5" sh17.5"											
three seat wall mount unit											
shipping 120 lbs.											

tables - cluster only

Laminate

- Standard Arconas laminates

to order specify

- Product name
- Model number
- Finish
- Fabric as appropriate
- Layout

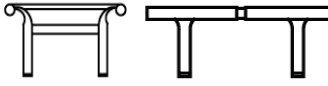
Model No.	Upholstery		Metal	C.O.M.	A	B	C	D	E	F	G	H
	Options											
 SETZ2B w44" d23.5" sh17.5"	No Upholstery	431										
	Seat Pad	1 yd	587	587	599	611	623	634	646	658	670	
two seat bench unit											shipping 100 lbs. 20 cu.ft.	

SETZ3B w67" d23.5" sh17.5"	No Upholstery	543										
	Seat Pad	1.5 yds	766	766	783	801	819	837	854	872	890	
three seat bench unit											shipping 150 lbs. 29 cu.ft.	

SETZ4B w90" d23.5" sh17.5"	No Upholstery	658										
	Seat Pad	2 yds	949	949	973	997	1020	1044	1067	1091	1114	
four seat bench unit											shipping 200 lbs. 39 cu.ft.	

SETZ5B w113" d23.5" sh17.5"	No Upholstery	760										
	Seat Pad	2.5 yds	1116	1116	1145	1175	1204	1234	1263	1292	1322	
five seat bench unit											shipping 250 lbs. 48 cu.ft.	

Cuff bench

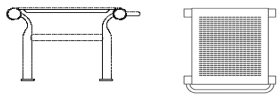
Model No.	Upholstery		Metal	C.O.M.	A	B	C	D	E	F	G	H
	Options											
 SETZ1BC w25" d23.5" sh17.5"	No Upholstery	652										
	Seat Pad	.5 yd	765	765	771	777	783	788	794	800	806	
one seat bench with handcuff rail											shipping 50 lbs. 20 cu.ft.	

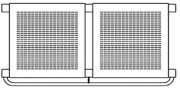
 SETZ2BC w44" d23.5" sh17.5"	No Upholstery	824										
	Seat Pad	1 yds	982	982	994	1005	1017	1029	1041	1052	1064	
two seat bench with handcuff rail											shipping 100 lbs. 29 cu.ft.	

SETZ3BC w67" d23.5" sh17.5"	No Upholstery	1064										
	Seat Pad	1.5 yds	1298	1298	1315	1333	1351	1368	1386	1404	1421	
three seat bench with handcuff rail											shipping 150 lbs. 29 cu.ft.	

SETZ4BC w90" d23.5" sh17.5"	No Upholstery	1298										
	Seat Pad	2 yds	1589	1589	1612	1636	1659	1683	1707	1730	1754	
four seat bench with handcuff rail and central leg											shipping 200 lbs. 39 cu.ft.	

cuff bench construction







- Heavy duty all steel structure
- Sealed steel end caps
- Tamper resistant hardware
- Floor mounting pads
- Handcuff rail

finish

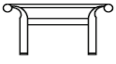
- Hammered paint
- See Arconas Standards

to order specify

- Product name
- Model number
- Finish
- Fabric as appropriate
- Layout

Model No.	Price		
	36		
SETZARM w2" d23.5" ah24"	arm, all metal		shipping .5 lbs.
 	311		
SETZET w21" d23.5" h17.5"	end table		shipping .40 lbs.
 	485		
SETZDT w21" d49" h17.5"	double end table, for back to back units		shipping .50 lbs.
	46		
SETZCONNT	"T" connector secures units at 90 degrees		shipping .5 lbs.
	13		
SETZCONN	in-line connector		shipping .5 lbs.
	44		
GLIDE-FLOOR	floor mounting glides (per unit)		shipping .5 lbs.

morelli bench

designer Morelli Designers

public and modular

Model No.	Price		
 MOR2SM w66" d21" h17.75"	906	2 seat all metal bench	shipping 68lbs
 MOR3SM w84" d21" h17.75"	1133	3 seat all metal bench	shipping 90lbs
 MOR2SWO w66" d21" h17.75"	1133	2 seat ipe wood bench	shipping 68lbs

options

- Ipe wood slats
- Perforated steel planks

finishes

- Legs
 - cloud silver or textured black
- Metal Planks
 - cloud silver or textured black
- Ipe Wood Slats
 - natural finish

to order specify

- Product name
- Model number
- Finishes

lounge

connex
datum
twenty-twenty

ARCONAS

CONNEX product map

designer johannes scherr

modular lounge

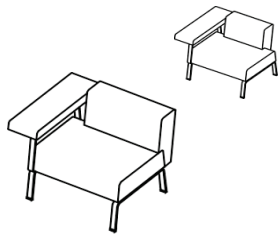

armchair (arm left or right)

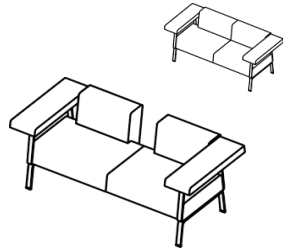

two seat sofa with arms

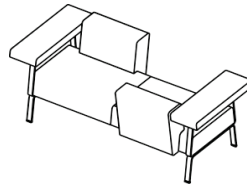

two seat twist sofa

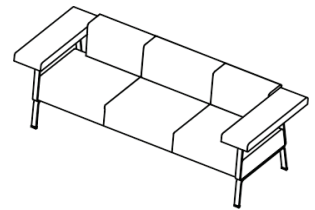

three seat sofa with arms



chair, no arms

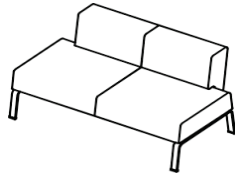

two seat sofa, no arms

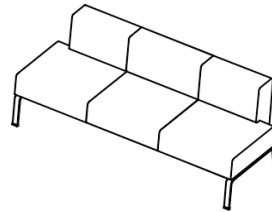

three seat sofa, no arms

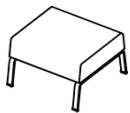

ottoman

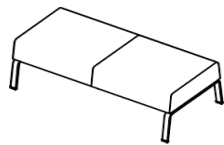

two seat bench

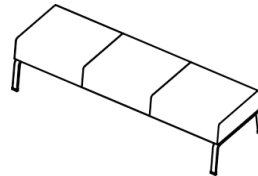

three seat bench



chair, full back, no arms

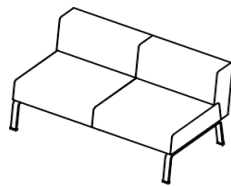

two seat, full back, no arms

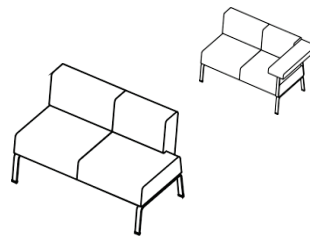

two seat, one side flush

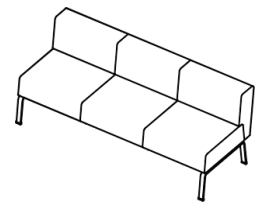

three seat, full back, no arms

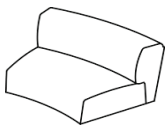

30° inside/outside wedge



45° inside/outside wedge

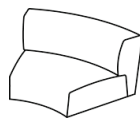

30° bench



45° bench



90°
connecting table



12"
inline connecting tables



24"

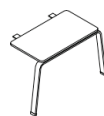

12"
end tables

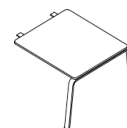

24"



end
legs



connecting

ARCONAS

52 - GSA Price List

1-800-387-9496

07.20

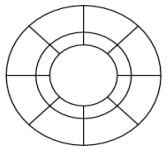

8'

45° outside wedge

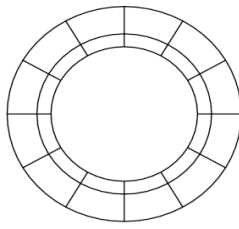

12'

30° outside wedge

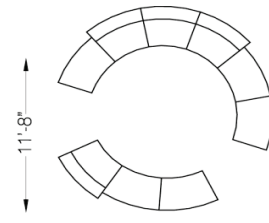

11'-8"

11'-1"

30° inside wedge + benches

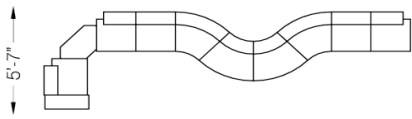

5'-7"

24'

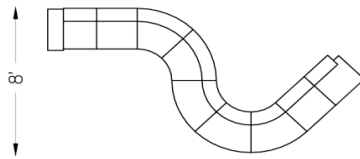

8'

16'

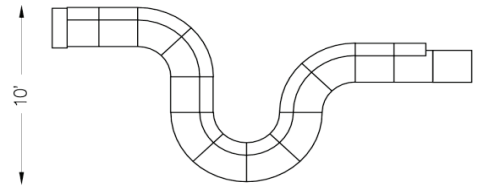

10'

22'-2"

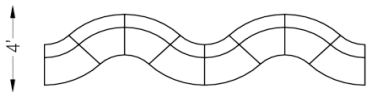

4'

16'-3"

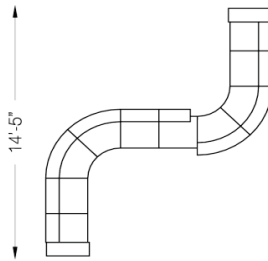

14'-5"

12'-1"

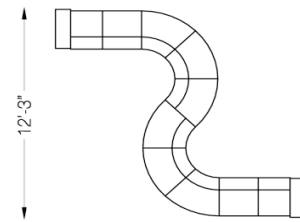

12'-3"

13'-1"

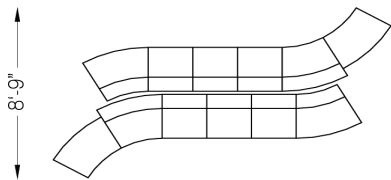

8'-9"

23'-10"

back to back

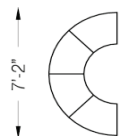

7'-2"

3'-7"

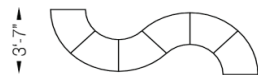

8'-7"

11'

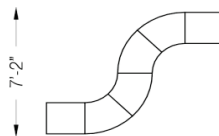

7'-2"

9'-5"

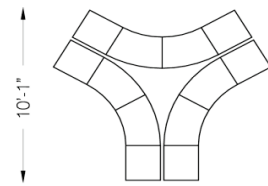

10'-1"

11'-7"

benches

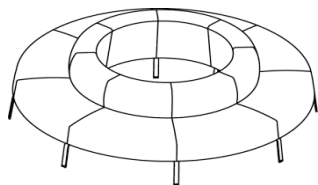

Calculating **Atrium** Configuration
 45 outside degree wedges in Grade A fabric
 = (8 x CON1450C) + (8 x CONCLEG)
 = (8 x 832) + (8 x 77)
 = 6656 + 616
 = \$7272

NOTE:
 The cost of the end leg on linear units
 is included in the chair price.

atrium

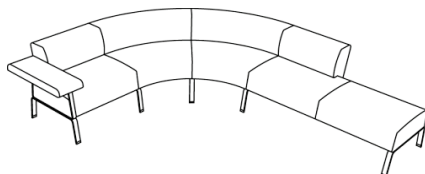

Calculating **Waiting Area** Configuration
 Armchair + 45 degree inside wedges + chair + ottoman in Grade C fabric
 = CON10AR + (2 x CON1451C) + CON10FR + CON01B + (3 x CONCLEG) + (2 x CONLEG)
 = 762 + (2 x 954) + 777 + 461 + (3 x 77) + (2 x 40)
 = 762 + 1908 + 777 + 461 + 231 + 80
 = \$4219

waiting area

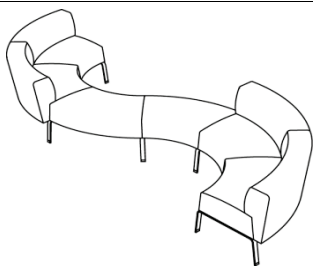

Calculating **Library** Configuration
 30 degree inside wedges + 30 degree bench in Grade G fabric
 = (4 x CON1301C) + (2 x CON130B) + (5 x CONCLEG) + (2 x CONLEG)
 = (4 x 1153) + (2 x 727) + (5 x 77) + (2 x 40)
 = 4612 + 1454 + 385 + 80
 = \$6531

library

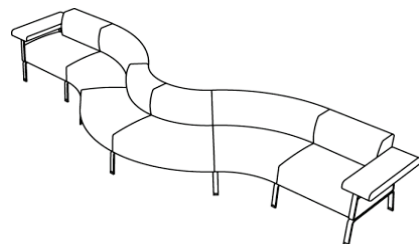

Calculating **Public Spaces** Configuration
 45 degree inside wedges + 45 degree outside wedges + armchairs in Grade B fabric
 = (2 x CON1451C) + (2 x CON1450C) + CON10AL + CON10AR + (5 x CONCLEG) + (2 x CONLEG)
 = (2 x 922) + (2 x 864) + 736 + 736 + (5 x 77) + (2 x 40)
 = 1844 + 1728 + 736 + 736 + 385 + 80
 = \$5509

public spaces

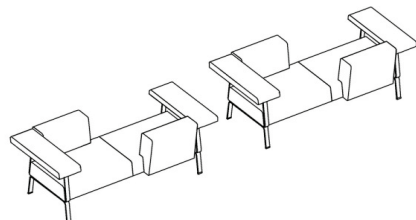

Calculating **Twist Sofas** Configuration
 twist sofa + twist sofa in Grade H fabric
 = CON22TA + CON22TA + (4 x CONLEG)
 = 1645 + 1645 + 160
 = \$3450

twist sofas in a business lounge

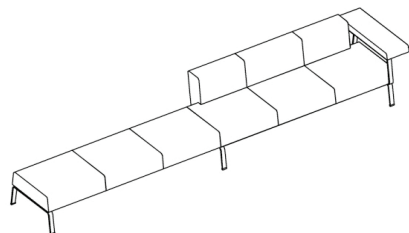

Calculating **Reception Area** Configuration
 3 seat bench + connecting leg + 3 seat sofa with arm on left in Grade E fabric
 = CON03B + CONCLEG + (2 x CONLEG) + CON30AL
 = 1331 + 77 + (2 x 40) + 2219
 = 1331 + 77 + 80 + 2219
 = \$3707

reception area

CONNEX arm chair and sofas

designer johannes scherr

modular lounge

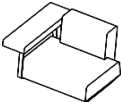
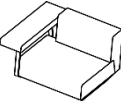
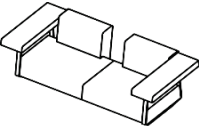
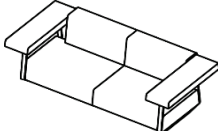
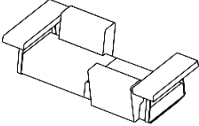
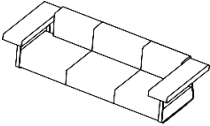
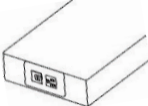
Model No.	C.O.M.	A	B	C	D	E	F	G	H	
	710	710	736	762	788	814	841	867	893	
2.25 yds										
CON10AL/R									shipping 72 lbs. 27 cu.ft.	
w34" d28.5" h29" sh17.5" ah28.5"	armchair, arm on left or right when seated									
	725	725	751	777	803	830	856	882	909	
2.25 yds										
CON10FAL/R									shipping 65 lbs. 27 cu.ft.	
w34" d28.5" h29" sh17.5" ah28.5"	armchair with flush back, arm on left or right when seated									
	1277	1277	1330	1382	1435	1488	1540	1592	1645	
4.5 yds										
CON20A									shipping 132 lbs. 45 cu.ft.	
w68" d28.5" h29" sh17.5" ah28.5"	two seat sofa with arms									
	1308	1308	1361	1413	1466	1518	1571	1623	1676	
4.5 yds										
CON20FA									shipping 135 lbs. 45 cu.ft.	
w68" d28.5" h29" sh17.5" ah28.5"	two seat sofa, full back with arms									
	1277	1277	1330	1382	1435	1488	1540	1592	1645	
4.5 yds										
CON22TA									shipping 132 lbs. 45 cu.ft.	
w68" d28.5" h29" sh17.5" ah28.5"	twist sofa									
	1916	1916	1991	2068	2143	2219	2295	2371	2447	
6.5 yds										
CON30A									shipping 145 lbs. 55 cu.ft.	
w84" d28.5" h29" sh17.5" ah28.5"	three seat sofa with arms									
	264	each								
CONPOWARM	upcharge for powered-arm. (silver face plate, 1 AC + 2 USB, 6 ft cord).									
For use with units with 2 arms. For other electrical configurations, please contact customer service.										

CONNEX armless chair, sofas and benches

designer johannes scherr

modular lounge

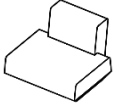
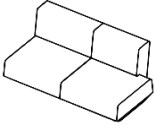
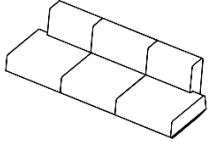
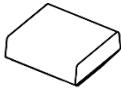
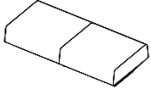
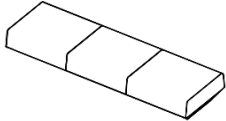
Model No.	C.O.M.	A	B	C	D	E	F	G	H
 CON10N w29.5" d28.5" h29" sh17.5" chair, no arms	608	608	631	654	678	701	725	748	771
	2 yds								
shipping 43 lbs. 27 cu.ft.									
 CON20N w59" d28.5" h29" sh17.5" two seat sofa, no arms	1083	1083	1129	1176	1223	1270	1316	1363	1410
	4 yds								
shipping 76 lbs. 40 cu.ft.									
 CON30N w75" d28.5" h29" sh17.5" three seat sofa, no arms	1623	1623	1693	1763	1833	1903	1973	2043	2113
	6 yds								
shipping 90 lbs. 50 cu.ft.									
 CON01B w25" d25" h17.5" ottoman	436	436	449	461	474	487	500	513	525
	1.1 yds								
shipping 30 lbs. 18 cu.ft.									
 CON02B w50" d25" h17.5" two seat bench	783	783	809	835	861	886	912	938	963
	2.2 yds								
shipping 53 lbs. 22 cu.ft.									
 CON03B w75" d25" h17.5" three seat bench	1177	1177	1216	1254	1293	1331	1369	1408	1446
	3.3 yds								
shipping 72 lbs. 32 cu.ft.									

CONNEX end elements

designer johannes scherr

modular lounge

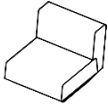
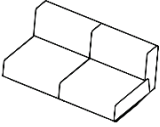
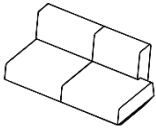
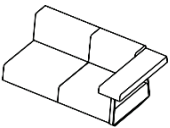
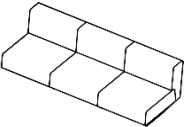
Model No.	C.O.M.	A	B	C	D	E	F	G	H	
	602	602	625	648	671	695	718	742	765	
	2 yds									
CON10F	flush full back chair, no arms								shipping 40 lbs. 27 cu.ft.	
w25" d28.5" h29" sh17.5"										
	1112	1112	1159	1206	1252	1299	1346	1392	1439	
	4 yds									
CON20F	two seat flush full back sofa, no arms								shipping 65 lbs. 40 cu.ft.	
w50" d28.5" h29" sh17.5"										
	1098	1098	1144	1191	1238	1284	1331	1378	1424	
	4 yds									
CON29FL/R	two seat flush back sofa, flush end on right or left when seated, no arms								shipping 65 lbs. 40 cu.ft.	
w50" d28.5" h29" sh17.5"										
	1200	1200	1250	1299	1348	1398	1448	1498	1547	
	4.25 yds									
CON29FAL/R	two seat flush back sofa, arm on left or right when seated								shipping 92 lbs. 40 cu.ft.	
w54.5" d28.5" h29" sh17.5"										
	1654	1654	1724	1794	1864	1934	2004	2074	2144	
	6 yds									
CON30F	three seat flush full back sofa, no arms								shipping 90 lbs. 50 cu.ft.	
w75" d28.5" h29" sh17.5"										

construction

Frame

- Kiln dried hardwood, hardwood plywood

Legs

- Steel

Foam

- Injected moulded CFC-free
fire retardant HR urethane

options

Connecting leg - no charge

- Connects two units, removing one leg

finishes

Leg and arm supports

- Powder coat - Cloud silver







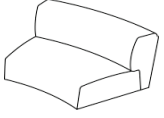
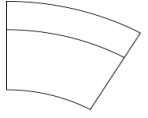
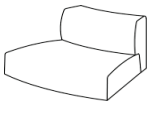

to order specify

- Product name
- Model number
- Right or Left arms as appropriate
- Leg & arm supports finish
- Fabric
- Layout

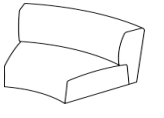
CONNEX curvilinear elements (must be connected)

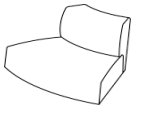
designer johannes scherr

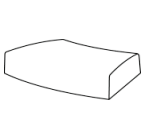
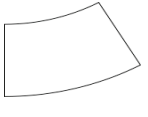
modular lounge

Model No.	C.O.M.	A	B	C	D	E	F	G	H	
 	943	943	978	1013	1048	1083	1118	1153	1188	
3 yds										
CON1301C									shipping 35 lbs. 26 cu.ft.	
w23.5-37.5" d28.5" h29" sh17.5"	30 degree inside wedge									
 	890	890	922	954	986	1019	1051	1083	1115	
2.75 yds										
CON1300C									shipping 28 lbs. 26 cu.ft.	
w37.5-23.5" d28.5" h29" sh17.5"	30 degree outside wedge									
 	890	890	922	954	986	1019	1051	1083	1115	
2.75 yds										
CON1451C									shipping 33 lbs. 26 cu.ft.	
w16-36.5" d28.5" h29" sh17.5"	45 degree inside wedge									
 	832	832	864	896	929	961	993	1025	1057	
2.75 yds										
CON1450C									shipping 30 lbs. 26 cu.ft.	
w36.5-16" d28.5" h29" sh17.5"	45 degree outside wedge									
 	622	622	639	657	674	692	709	727	744	
1.5 yds										
CON130B									shipping 23 lbs. 21 cu.ft.	
w37.5-26" d25" h17.5"	30 degree bench									
 	595	595	613	630	647	665	683	700	718	
1.5 yds										
CON145B									shipping 24 lbs. 21 cu.ft.	
w34-16" d25" h17.5"	45 degree bench									

upholstery for curved units

- Solid, non-repeat fabrics with some stretch are best suited for curved units.
- Yardage requirement will vary according to combination of units and fabric specified.
- Submit sample to confirm yardage and workability.

legs for curved units

- Sold separately

connex legs

designer johannes scherr

modular lounge

Model No. Powder coat - Cloud silver

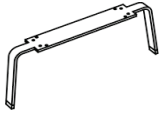

77

CONCLEG

w2.5" d24.5" h9.75"

connecting centre leg

shipping 10 lbs.

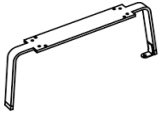

92

CONCLEGF

w2.5" d24.5" h9.75"

connecting leg, with floor mounting bracket

shipping 10 lbs.



40

CONLEG

w1.5" d24.5" h9.75"

end leg

shipping 7 lbs.



63

CONLEGF

w1.5" d24.5" h9.75"

end leg, with floor mounting bracket

shipping 7 lbs.

legs

- Steel

finishes

Legs

- Powder coat - Cloud silver

options

Connecting leg - no charge

- Connects two units, removing one leg

connex tables

designer johannes scherr

modular lounge

Model No. Laminate

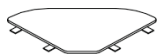

629

CON90C

w23" d23" h.75"

90° connecting table (mounted height 11.5")

shipping 12 lbs.



209

CON12N

w12.5" d21" h.75"

12" inline connecting table (mounted height 11.5")

shipping 6 lbs.

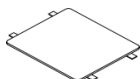

472

CON24N

w24" d21" h.75"

24" inline connecting table (mounted height 11.5")

shipping 12 lbs.



222

CON12E

w12" d21" h.11.5"

12" end table

shipping 15 lbs.

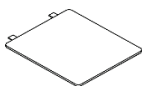

523

CON24E

w24" d21" h.11.5"

24" end table

shipping 21 lbs.

table

- Baltic birch with reversed beveled edge with laminate top

option

- power module mounted below table

finish

- standard Arconas laminates

Model No. Price



<u>Laminate Tabletop</u>	<u>Veneer Tabletop</u>
1923	2115

DATPC

w46" d46" h28"

powder coat frame with adjustable glides

shipping 100 lbs.



<u>Laminate Tabletop</u>	<u>Veneer Tabletop</u>
2982	3221

DATSS

w46" d46" h28"

stainless steel frame with adjustable glides

shipping 100 lbs.

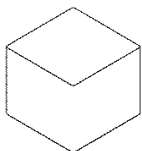

C.O.M.	A	B	C	D	E	F	G	H
311	311	337	363	389	415	441	468	494
2.25 yds								

TWENOTTS

w20" d20" h17"

ottoman (price per unit)

shipping 20 lbs.

166

DATPOW

w4" d4" h2"

moirè power hub - two AC connections & two USB ports

shipping specifications

Datum is shipped fully assembled. Datum occupies 37 cu.ft. and every ottoman occupies an estimated 4 cu.ft. of shipping space. A minimum order will occupy an estimated 37 cu.ft. Please contact factory for specific shipping specifications. Weight is as shown above.

construction

Tabletop

- Baltic birch with reversed beveled edge with laminate or veneer top

Frame

- Welded steel

Ottomans

- Injected moulded BioFoam
- CFC-free fire retardant H.R. urethane
- low V.O.C. & formaldehyde free

finish

frame

- standard Arconas powder coat
- upgrade - stainless steel

table glides

- nylon/metal adjustable glides

ottoman glides

- Standard - nylon glides
- Castors - call for pricing.

tabletop

- standard Arconas laminates
- upgrade - wood veneer

moirè power hub

- Options: four AC outlets or four USB ports

to order specify

- Product name
- Model number
- Finish
- Fabric as appropriate
- Top finish as appropriate
- Layout

twenty-twenty ottomans

designer arconas

modular lounge

Model No.	C.O.M.	A	B	C	D	E	F	G	H
-----------	--------	---	---	---	---	---	---	---	---

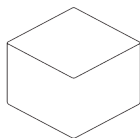

691	691	749	806	864	923	981	1038	1096
-----	-----	-----	-----	-----	-----	-----	------	------

2.25 yds

TWENOTTS

w20" d20" h17"

square ottoman

shipping 20 lbs.

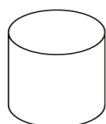
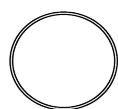

628	628	674	718	763	809	854	898	943
-----	-----	-----	-----	-----	-----	-----	-----	-----

1.75 yds

TWEN5115OTT

d20" h17.5"

round ottoman

shipping 20 lbs.

shipping specifications

Ottomans are shipped fully assembled. Every ottoman occupies an estimated 2 cu.ft. of shipping space. A minimum order will occupy an estimated 2 cu.ft. Please contact factory for specific shipping specifications. Weights shown above.

construction

Ottoman

Injected moulded BioFoam

- CFC-free fire retardant H.R. urethane
- Low V.O.C.
- Formaldehyde free

top

Upholstered

Solid surface

- white corian

feet

Standard - nylon glides

Castors - Call for pricing

to order specify

- Product name
- Model number
- Fabric

power





inPower™ bar
inPower™ flex

ARCONAS

inPower™ bar counter system

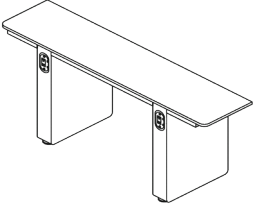
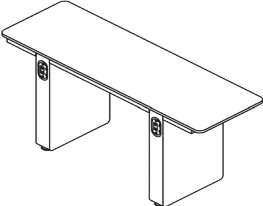
designer swave studios

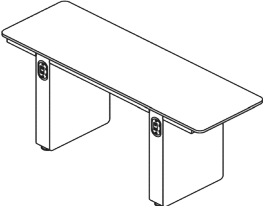
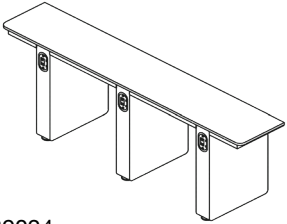
power

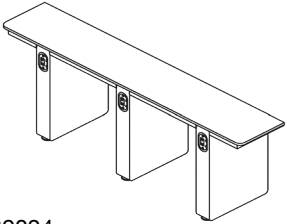
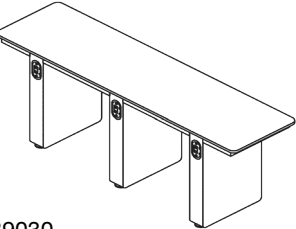
Model No.	Laminate top	Solid surface top	Upholstered Gables Grade A Fabric
 <p>PB6024 w60" d24" h36"</p>	2345	836	132 set of two
<p>counter depth bar with white laminate leg panels. Unit includes 2 legs and 2 inPower flex modules and is floor fastened. Distance between legs: 25" shipping 500 lbs.</p>			
 <p>PB6024ADA w60" d24" h32"</p>			
<p> wheelchair accessible counter depth bar with white laminate leg panels. Unit includes 2 legs and 2 inPower flex modules and is floor fastened. Distance between legs: 30" shipping 500 lbs.</p>			
 <p>PB6030 w60" d30" h36"</p>	2946	1172	132 set of two
<p>free-standing counter with white laminate leg panels. Unit includes 2 legs and 4 inPower flex modules. Distance between legs: 25" shipping 500 lbs.</p>			
 <p>PB6030ADA w60" d30" h32"</p>			
<p> wheelchair accessible counter with white laminate leg panels. Unit includes 2 legs and 4 inPower flex modules and is floor fastened. Distance between legs: 30" shipping 500 lbs.</p>			
 <p>PB9024 w90" d24" h36"</p>	3521	956	132 set of two
<p>counter depth bar with white laminate leg panels. Unit includes 3 legs and 3 inPower flex modules and is floor fastened. Distance between legs: 25" shipping 700 lbs.</p>			
 <p>PB9030 w90" d30" h36"</p>	4714	1413	132 set of two
<p>free-standing counter with white laminate leg panels. Unit includes 3 legs and 6 inPower flex modules and is floor fastened. Distance between legs: 25" shipping 700 lbs.</p>			

inPower™ flex provides power for the most common personal electronic devices such as laptop computers, DVD players, PDAs, MP3 Players, PSPs, digital cameras, etc.

This unique power source comes in two options: the inPower flex, and inPower flex 3. The inPower flex consists of a module with dual receptacles for **120 VAC** and two **5 VDC USB ports**. The inPower flex 3 consists of two receptacles for 120 VAC, and two 5 VDC USB-C ports. The receptacles can be connected in series to power many modules from a single source. Modules can be mounted on linear units and back-to-back units, under intermediate or connecting tables and under cluster tabletops. Special brackets are provided for each specific application.

The inPower™ flex system is designed to minimize tripping of the building circuit breakers. This will minimize the need to access the electrical closets when an overload occurs.

InPower units are available for North America, Europe (U.K.), India and Universal.

The inPower flex module includes a circuit breaker to limit the current that can be drawn by a user to approximately 5 AC (600 watts). This prevents the use of high current devices (hair dryers, travel irons, vacuums, etc.), while allowing the use of all consumer electronics. When a high current device is used, only the one receptacle module shuts down, and can be easily reset by resetting the circuit breaker. Modules also feature tamper resistant electrical receptacles.

overview



inPower™ flex

power capacity

- 120 VAC 12 A for daisy chained system
- 120 VAC 5A maximum for each module
- 5 VDC 2100 mA maximum for each USB receptacle

Daisy chains are used to connect one unit to another from a single wall receptacle.

Up to 5 power modules can be connected in a series.

daisy chain

Maximum 32 feet of jumper cable length in a series.

Inlet power daisy chain limit - resettable breaker with fault indication

- Daisy chain 12 Amp max
- Module limit - resettable breaker 5 Amps

InPower flex features GFI with test and reset buttons and fault indicator light

protection

2500 MA over-current protection on USB

warranty

Arconas warrants inPower™ Flex components against defects in parts and workmanship as for a period of 1 year from the date of the initial installation. The inPower™ Flex components must be properly installed and maintained in a dry indoor location and used for their intended purposes.

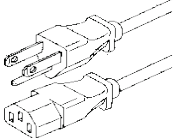
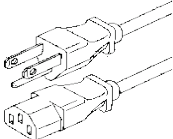
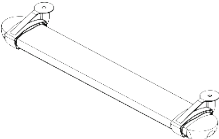
Model No.	Price		
	317		
IP2500 w6.7" d6.3" h3.3"		inPower flex kit (inc. power module with seat / table bracket and 6' jumper / power cord). Includes dual AC receptacles and two USB ports	shipping 1.5 lbs.
	11		
IP2511		8 foot or 10 foot jumper / power cord (upcharge)	shipping .5 lb.
	16		
IP2512		12 foot or 15 foot jumper / power cord (upcharge)	shipping .5 lb.
	32		
IP2510		cable management device (Flyaway only)	shipping 1.5 lbs.
	call for pricing		
IP2513		custom seat bracket for non-Arconas products	shipping 2 lbs.

inPower Flex

construction

Face Plate

- Die-cast aluminum

Shell

- Molded nylon case

LED Panel

- Blue LED indicator light

finish

Face plate

- Satin polished

Shell colour

- Black

inPower Flex 3

construction

Face Plate

- Die-cast aluminum

Shell

- Die-cast aluminum

LED Panel

- Blue LED indicator light

finish

Face plate

- Black

Shell colour

- Black

options

- Brackets available for all Arconas beam seating.
- Alternative brackets can be designed to affix inPower Flex to non-Arconas seating.
- International version available at 220V
- Mounts below tables

additional information

For additional more information on the inPower flex, please refer to the product's specifications or visit www.inpowerflex.com

to order specify

- Product name
- Model number
- Bracket model number

waste, recycling, and outdoor

bike rack
x series

ARCONAS

Model No. Price



BRX1PC

Powder coated

162

w4" d19" h27"

bikerax with one hoop

shipping 12lbs

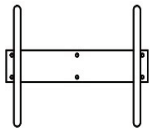

BRX2PC

Powder coated

298

w26" d19" h27"

bikerax with two hoops

shipping 24lbs

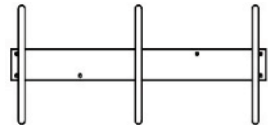

BRX3PC

Powder coated

389

w48" d19" h27"

bikerax with three hoops

shipping 36lbs

material

- 12 guage steel tube
- 3/16" base plates
- zinc plated under coat protection

finishes

- Powder coat, Arconas standards

Note: Requires floor mounting. Hardware not provided.

X series product map

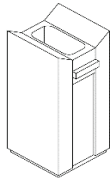
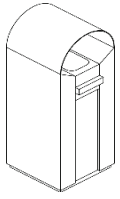

53 litres (14 gallons)

trashbox, with hood

trashbox, without hood

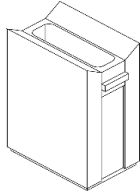
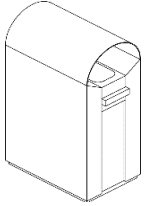

85 litres (22.5 gallons)

super trashbox, with hood

super trashbox, without hood

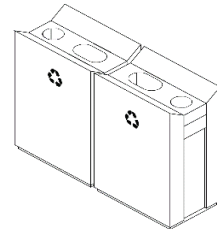
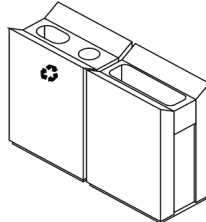
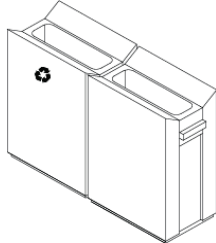
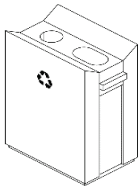

76 litres (20 gallons)

161 litres (42.5 gallons)

161 litres (42.5 gallons)

151 litres (40 gallons)

rux II

rux II MAX

rux III

rux IV

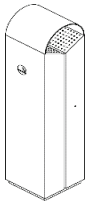

smokestax with hood

smokestax, wall mounted

smokebox, wall mounted

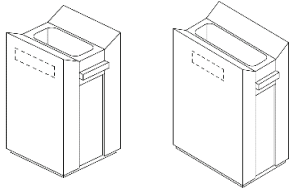

optional graphics

Corporate graphic vinyl on front panel

- Average vinyl size: w10" x h3"

to order specify

- Graphic size
- Graphic colors (Pantone)
- File format AI, EPS, TIFF, JPG
- File resolution 300dpi

trashbox and super trashbox

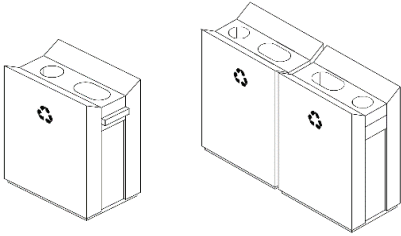

standard front panel graphics

Recycling symbol

- Vinyl size: w4" x h4"
- Symbol color: green



to order specify

- Graphic size

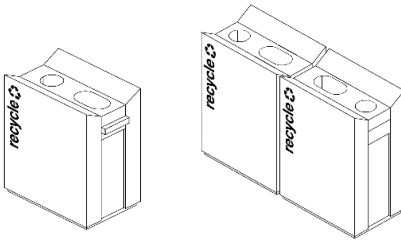

upgraded front panel graphics

Recycling symbol and text

- Vinyl size: w3.75" x h18"
- Symbol color: green
- Text color
 - Blue
 - Dark grey
 - Silver metallic



to order specify

- Graphic size
- Text color

rux II and rux IV

Specify sorting symbol locations

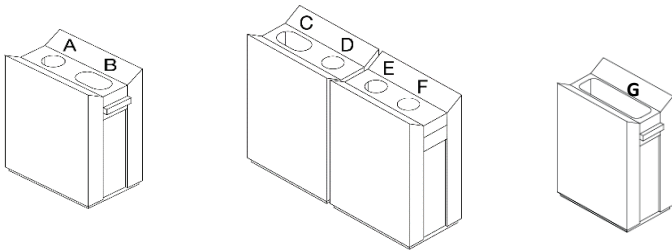

A _____ C _____ E _____ G _____
 B _____ D _____ F _____

rux II and rux IV

standard sorting symbols on lid

- Vinyl size: Approximately w5" x h4"
- Symbol and text color
 - Dark grey, silver metallic, or white



- to order specify**
- Graphic size
 - Graphic color
 - Sorting symbol locations (left)

rux II and rux IV

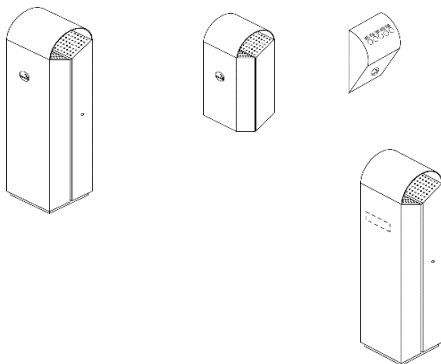

standard graphics

Smoking symbol on front panel

- Vinyl size: dia 2.5"
- Symbol color
 - Dark grey
 - Silver metallic



to order specify

- Graphic size
- Graphic color

optional graphics

Corporate graphic on front panel

- Average vinyl size: w6" x h2"

to order specify

- Graphic size
- Graphic colors (Pantone)
- File format AI, EPS, TIFF, JPG
- File resolution 300dpi

smokestax and smokebox

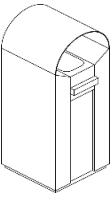
Model No.		Price
	X3TEHPC	Powder coated panels 600
	X3TEHSP	Stainless steel front and rear panels, powder coated accents 812
	X3TEHAS	All stainless steel 916
w16.5" d15" h40"	trashbox, exterior trash receptacle with hood, 53 litres (14 gallons)	shipping 78 lbs. 7 cu.ft.

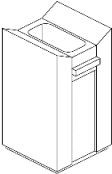
	X3TEPC	Powder coated panels 551
	X3TESP	Stainless steel front and rear panels, powder coated accents 741
	X3TEAS	All stainless steel 822
w16.5" d15" h33"	trashbox, interior / exterior trash receptacle without hood, 53 litres (14 gallons)	shipping 72 lbs. 6 cu.ft.

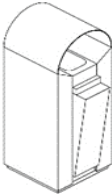
	X3TEHPC-X3APC	Powder coated 754
	X3TEHSP-X3APC	Powder coated 965
	X3TEHAS-X3ASS	Stainless steel 1136
w16.5" d15" h40"	trashbox, exterior trash receptacle with hood and ashbox, 53 litres (14 gallons)	shipping 78 lbs. 7 cu.ft.

construction & features

Recessed Base and Body

- Steel and/or stainless steel

Exterior steel models

- Zinc undercoat

Lid

- Hinged and chained

Freestanding or floor fastened

- Unit ships standard with floor fastening hardware

Adjustable levelling glides

Polyethylene liner

Allen key lock

finish

Powder coat

- Standard X Series finishes

Brushed stainless steel

options

- Custom corporate or sponsor graphics - Call for pricing
- Custom openings
- Custom colours
- Custom graphic programs available to meet you specific needs
- Call for pricing

to order specify

- Product name
- Model number
- Finish
- Graphic
- Graphic colour, if any
- Corporate graphics, if any

x series: super trashbox®

waste and recycling bins

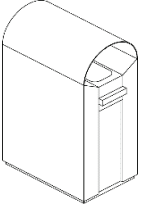
Model No.		Price	
	X3SEHPC	Powder coated panels	642
	X3SEHSP	Stainless steel front and rear panels, powder coated accents	858
	X3SEHAS	All stainless steel	1074
	X3SEHPC-PPE	Powder coated in light blue with PPE decals	642
w23.5" d15" h40"	super trashbox, exterior trash receptacle with hood, 85 litres (22.5 gallons)		shipping 108 lbs. 10 cu.ft.

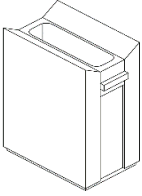
	X3SEPC	Powder coated panels	580
	X3SESP	Stainless steel front and rear panels, powder coated accents	786
	X3SEAS	All stainless steel	960
	X3SEPC-PPE	Powder coated in light blue with PPE decals	580
w23.5" d15" h33"	super trashbox, interior / exterior trash receptacle without hood, 85 litres (22.5 gallons)		shipping 102 lbs. 9 cu.ft.

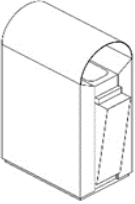
	X3SEHPC-X3APC	Powder coated	796
	X3SEHSP-X3APC	Powder coated	1012
	X3SEHAS-X3ASS	Stainless steel	1294
w23.5" d15" h40"	super trashbox, exterior trash receptacle with hood and ashbox, 86 litres (23 gallons)		shipping 108 lbs. 10 cu.ft.

x series: rux® II, rux® III & rux® IV

waste and recycling bins

Model No. Price

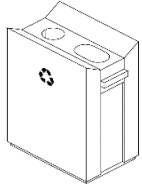

X3R2EPC	Powder coated panels	654
X3R2ESP	Stainless steel front and rear panels, powder coated accents	846
X3R2EAS	All stainless steel	1027

w23.5" d15" h33"

rux II, recycling unit, 76 litres (20 gallons)

shipping 102 lbs. 9 cu.ft.

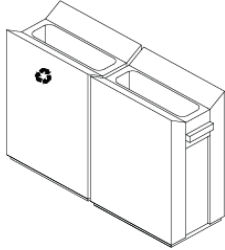

X3RR21PC	Powder coated panels	1284
X3RR21SP	Stainless steel front and rear panels, powder coated accents	1690
X3RR21AS	All stainless steel	2015

w47" d15" h33"

rux II MAX, super trashbox unit, 161 litres (42.5 gallons)

shipping 204 lbs. 18 cu.ft.

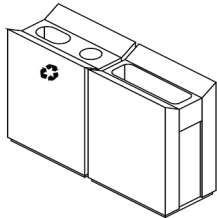

X3R3IPC	Powder coated panels	1284
X3R3ISP	Stainless steel front and rear panels, powder coated accents	1690
X3R3IAS	All stainless steel	2015

w47" d15" h33"

rux III, recycling and trashbox units, 161 litres (42.5 gallons)

shipping 204 lbs. 18 cu.ft.

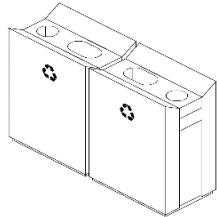

X3R4IPC	Powder coated panels	1284
X3R4ISP	Stainless steel front and rear panels, powder coated accents	1690
X3R4IAS	All stainless steel	2015

w45" d15" h33"

rux IV, recycling unit, 151 litres (40 gallons)

shipping 204 lbs. 18 cu.ft.

to order specify

- Product name
- Model number
- Finish
- Sorting Symbols
- see page 78

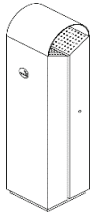
Model No.		Price
	X3SSPC	Powder coated panels 419
	X3SSSP	Stainless steel front and rear panels, powder coated accents 629
	X3SSAS	All stainless steel 739
w9" d8.5" h44.5"	smokestax, ashtray with hood	shipping 62 lbs. 3 cu.ft.

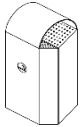
	X3SSWPC	Powder coated panels 311
	X3SSWSP	Stainless steel front and rear panels, powder coated accents 374
	X3SSWAS	All stainless steel 615
w9" d8.5" h27"	smokestax, wall mounted ashtray	shipping 38 lbs. 2 cu.ft.

	X3SBPC	Powder coated outer, stainless steel inner 257
	X3SBAS	All stainless steel 342
w9" d6.5" h16"	smokebox, wall mounted ashtray	shipping 18 lbs. 1 cu.ft.

construction & features

Recessed Base and Body

- Steel and/or stainless steel

Exterior steel models

- Zinc undercoat

Freestanding or floor fastened

- Unit ships standard with floor fastening hardware

Adjustable levelling glides

Allen key lock

finish

Powder coat

- Standard X Series finishes

Brushed stainless steel

standard graphics

- Smoking symbol

options

- Custom corporate or sponsor graphics - Call for pricing

to order specify

- Product name
- Model number
- Finish
- Graphic
- Graphic colour, if any
- Corporate graphics, if any

Model No. Price



2353

X3TEPC-GP-WAORPL

w47" d22" h44"

graph-x III sorting station

shipping 225 lbs



3047

X3TEPC-GP-ORWAPAPL

w62" d22" h44"

graph-x IV sorting station

shipping 300 lbs

construction & features

Recessed Base and Body

- 16ga. steel with polyester powder coated finish
- indoor use only

Units are on casters

finish

Powder coat

- Green - Organics
- Black - Waste
- Silver Metallic - Paper
- Blue - Metal/Glass/Plastic

to order specify

- Product name
- Model number
- Finishes
- Graphic colour, if any
- Corporate graphics, if any

standard graphics

- Arconas standard sorting graphics

options

- Custom corporate or sponsor graphics - Call for pricing

Model No. Price

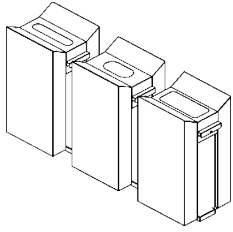

1872

X3TE3PC

w58.5" d15" h33"

lin-x III sorting station

shipping 225 lbs

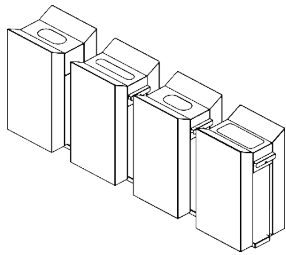

2496

X3TE4FDPC

w79.5" d15" h33"

lin-x IV sorting station

shipping 300 lbs

construction & features

Recessed Base and Body

- 16ga. steel with polyester powder coated finish
- indoor use only

Units are on casters

finish

Powder coat

- Green - Organics
- Brown - Waste
- Silver Metallic - Paper
- Blue - Metal/Glass/Plastic

to order specify

- Product name
- Model number
- Finishes
- Graphic colour, if any
- Corporate graphics, if any

standard graphics

- Arconas standard sorting graphics

options

- Custom corporate or sponsor graphics - Call for pricing



5700 Keaton Crescent
Mississauga, Ontario
Canada, L5R 3H5

Telephone: +1 905-272-0727
Toll Free: +1 800-387-9496
info@arconas.com

arconas.com

